



Section 7

BIT AND BARREL

Keys are separated by type - bit or barrel and are in number sequence

Some keys in this section are marked "DISCONTINUED", however they may still be available from Ilco distributors. We have left these in this directory for your reference.

DETERMINING SPECIFICATIONS ON BIT KEYS

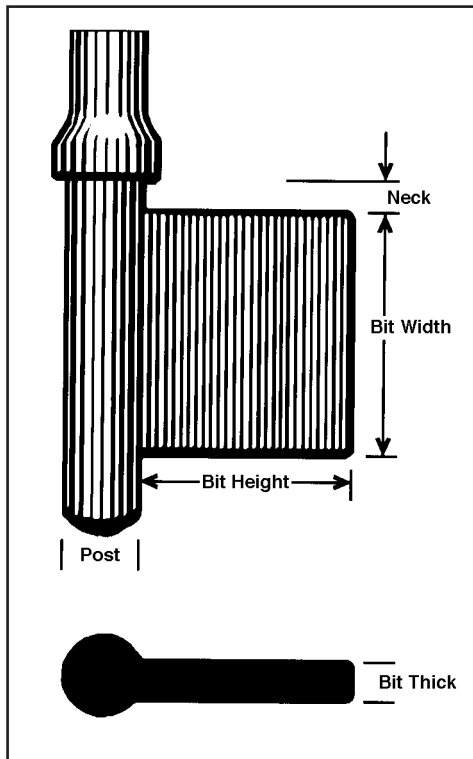

Dimensions of a Bit Key

The following pages show our selection of Bit and Barrel Key Blanks. This page will help you identify the key blank you are looking for.

- The chart below lists various types of materials used in Bit and Barrel key blanks.
- Measurements below each key drawing are shown in hundredths of an inch and tenths of a millimeter. Please understand that these styles of key blanks are not made to the same tolerances of cylinder key blanks by the nature of the processes utilized. If the dimensions are close they will more than likely work.

Diagrams (left) show how the bit and barrel keys are measured so you can understand what to measure for comparison.

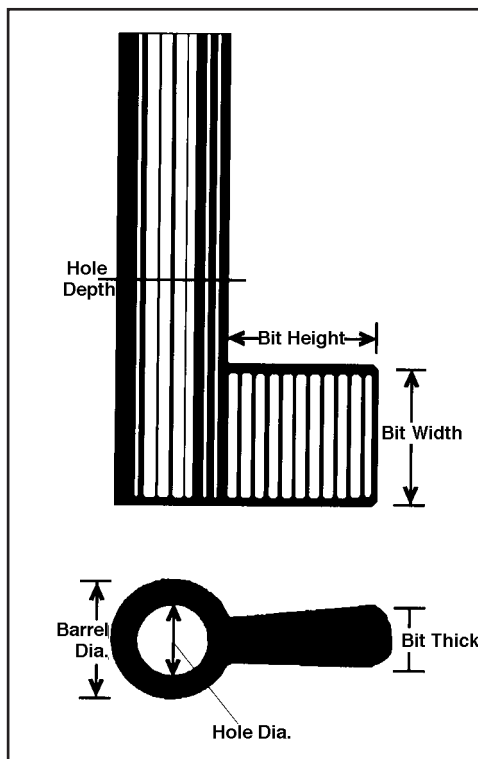

Dimensions of a Barrel Key

Materials Used

- MI** - malleable iron
- Steel/Plastic** - a nickel plated steel shaft with a plastic tip
- Steel/Zinc** - a nickel plated steel shaft with a die cast zinc tip
- Brass** - a brass die cast key blank
- Prec. Cast** - a precision zinc die cast key blank

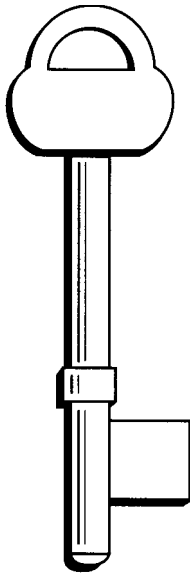
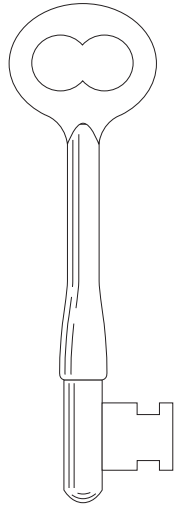
BIT KEYS

1B

P1

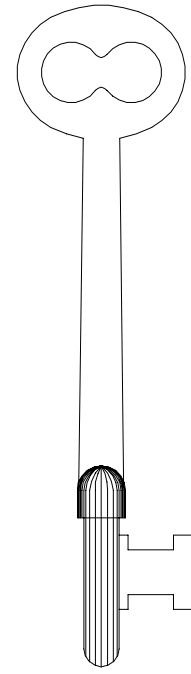
P8		P9	
MI		MI	
.20	(5.1mm)	.20	(5.1mm)
.10	(2.5mm)	.10	(2.5mm)
.37	(9.3mm)	.37	(9.3mm)
.37	(9.3mm)	.37	(9.3mm)
.14	(3.6mm)	.14	(3.6mm)

P6		P7	
MI		MI	
.20	(5.1mm)	.20	(5.1mm)
.10	(2.5mm)	.10	(2.5mm)
.37	(9.3mm)	.37	(9.3mm)
.37	(9.3mm)	.37	(9.3mm)
.14	(3.6mm)	.14	(3.6mm)

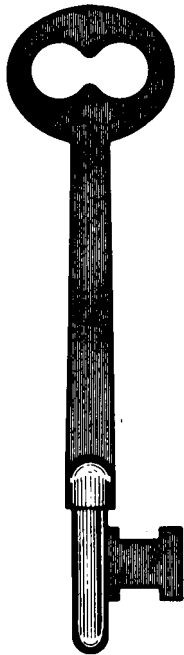
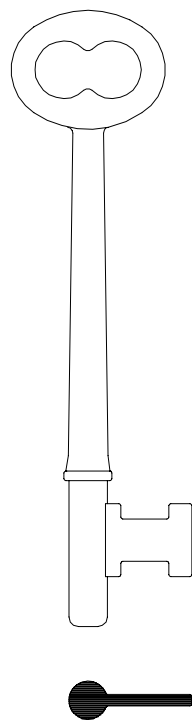
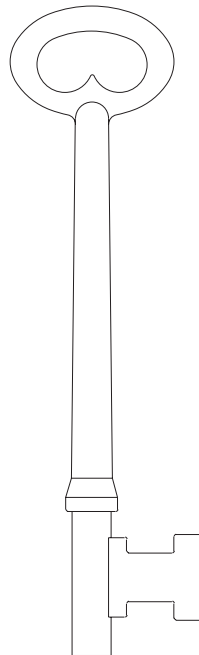
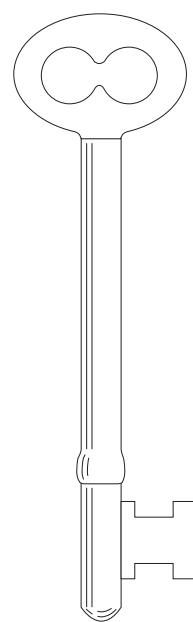
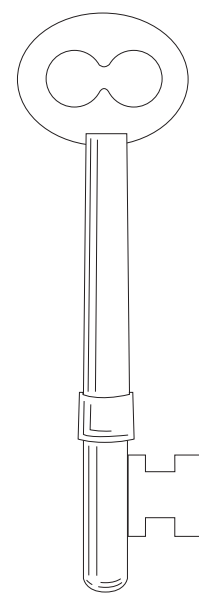
2B

ILCO
Material
Post
Neck
Bit Height
Bit Width
Bit Thick

BIT KEYS

B2M

3B

C3AM

C3M

D3

ILCO
Material
Post
Neck
Bit Height
Bit Width
Bit Thick

	B2M	3B	C3AM	C3M	D3
Material	STEEL/ZINC	MI	MI	PRECISION CAST	PRECISION CAST
Post	.19" (4.8mm)	.20" (5.1mm)	.21 (5.3mm)	.20 (5.1mm)	.20 (5.1mm)
Neck	.09" (2.3mm)	.12" (3.0mm)	.13 (3.3mm)	.13 (3.3mm)	.09 (2.3mm)
Bit Height	.39" (9.9mm)	.44" (11.2mm)	.47 (12mm)	.44 (11.2mm)	.44 (11.2mm)
Bit Width	.39" (9.9mm)	.38" (9.7mm)	.44 (11.2mm)	.38 (9.7mm)	.42 (10.7mm)
Bit Thick	.08" (2.0mm)	.06" (1.5mm)	.10 (2.5mm)	.06 (1.5mm)	.10 (2.5mm)

BIT KEYS

D4	5B	B5A	6B	B6	ILCO
PRECISION CAST	MI	STEEL/ZINC	MI	STEEL/ZINC	Material
.20 (5.1mm)	.20" (5.1mm)	.21" (5.3mm)	.21" (5.3mm)	.20" (5.1mm)	Post
.09 (2.3mm)	.09" (2.3mm)	.10" (2.5mm)	.09" (2.3mm)	.09" (2.3mm)	Neck
.43 (11mm)	.44" (11.2mm)	.50" (12.7mm)	.50" (12.7mm)	.47" (11.9mm)	Bit Height
.42 (10.7mm)	.50" (12.7mm)	.50" (12.7mm)	.50" (12.7mm)	.49" (12.4mm)	Bit Width
.10 (2.5mm)	.09" (2.3mm)	.10" (2.5mm)	.08" (2.0mm)	.08" (2.0mm)	Bit Thick

BIT KEYS

7B	B7M	8B	9B	B9	ILCO
STEEL/PLASTIC	STEEL/ZINC	MI	MI	STEEL/ZINC	Material
.20" (5.1mm)	.20" (5.1mm)	.19" (4.8mm)	.18" (4.6mm)	.21" (5.3mm)	Post
.10" (2.5mm)	.10" (2.5mm)	.08" (2.0mm)	.09" (2.3mm)	.09" (2.3mm)	Neck
.41" (10.4mm)	.41" (10.4mm)	.50" (12.7mm)	.53" (13.5mm)	.50" (12.7mm)	Bit Height
.39" (9.9mm)	.39" (9.9mm)	.45" (11.4mm)	.49" (12.4mm)	.49" (12.4mm)	Bit Width
.08" (2.0mm)	.08" (2.0mm)	.08" (2.0mm)	.07" (1.8mm)	.09" (2.3mm)	Bit Thick

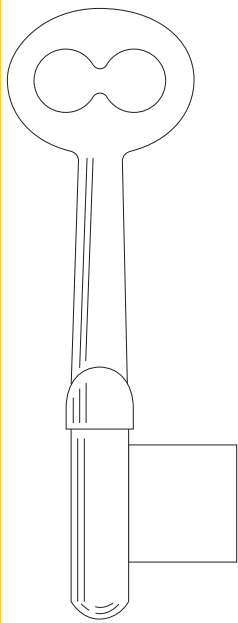
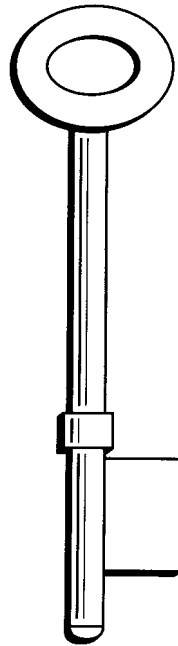
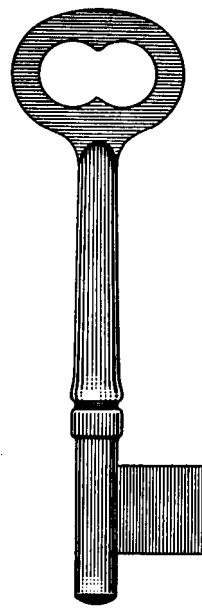
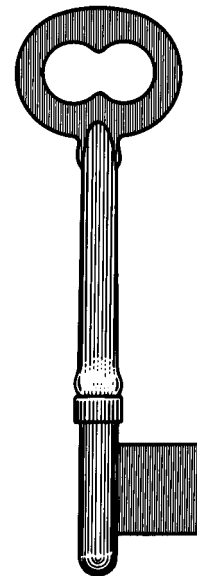
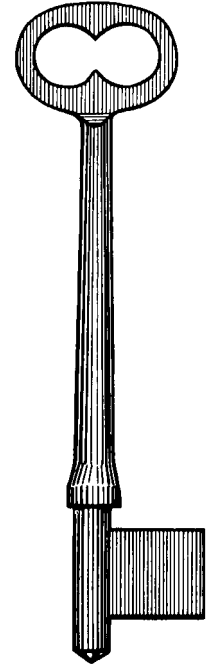
BIT KEYS

B11M

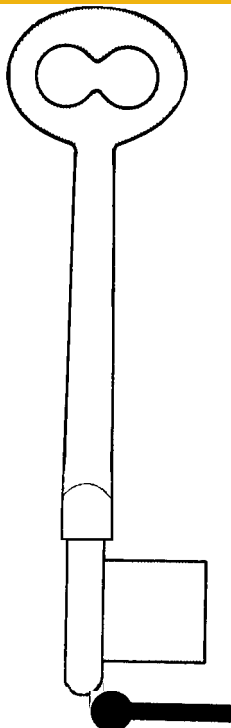
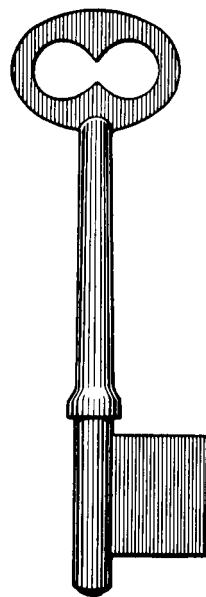
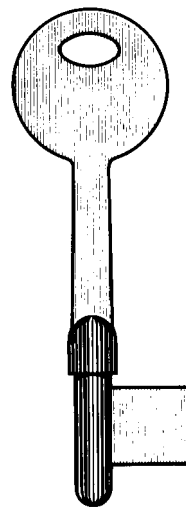
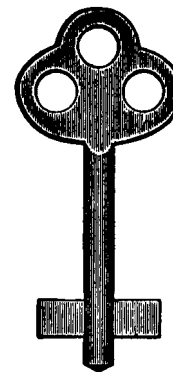
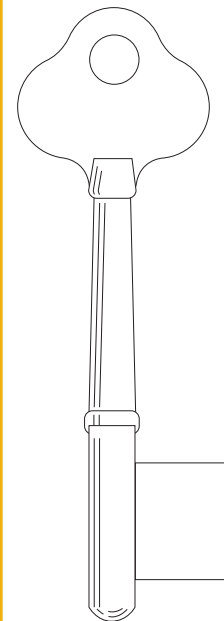
12B

14B

14CM

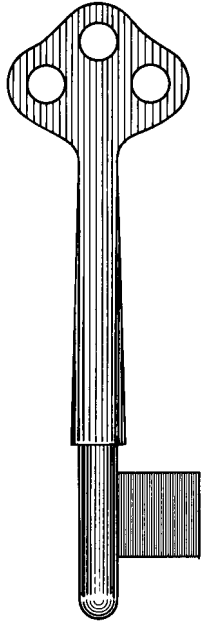
17B
ILCO

Material	BI-METALLIC	MI	MI	MI	MI
Post	.25 (6.4mm)	.19" (4.8mm)	.22" (5.6mm)	.19" (4.8mm)	.19" (4.8mm)
Neck	.08 (2.0mm)	.07" (1.8mm)	.15" (3.8mm)	.13" (3.3mm)	.09" (2.8mm)
Bit Height	.50 (12.7mm)	.45" (11.4mm)	.46" (11.7mm)	.44" (11.2mm)	.50" (12.7mm)
Bit Width	.56 (14.2mm)	.66" (16.8mm)	.48" (12.2mm)	.45" (11.4mm)	.50" (12.7mm)
Bit Thick	.11 (2.8mm)	.08" (2.0mm)	.16" (4.1mm)	.16" (4.1mm)	.08" (2.0mm)

BIT KEYS

B17

19B

B20

25B

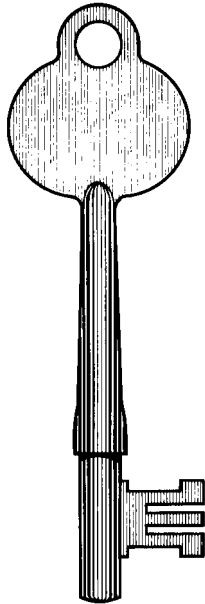
28AM
ILCO

Material	STEEL/ZINC	MI	STEEL/ZINC	MI	MI
Post	.19" (4.8mm)	.19" (4.8mm)	.17" (4.3mm)	.17" (4.3mm)	.23" (4.8mm)
Neck	.10" (2.5mm)	.07" (1.8mm)	.08" (2.0mm)	—	.08" (2.0mm)
Bit Height	.50" (12.7mm)	.50" (12.7mm)	.40" (10.2mm)	.69" overall (17.5mm)	.47" (11.9mm)
Bit Width	.50" (12.7mm)	.62" (15.7mm)	.47" (11.9mm)	.22" (5.6mm)	.63" (16mm)
Bit Thick	.08" (2.0mm)	.09" (2.3mm)	.10" (2.5mm)	.08" (2.0mm)	.16" (4.1mm)

BIT KEYS



28BM



37 MASTER

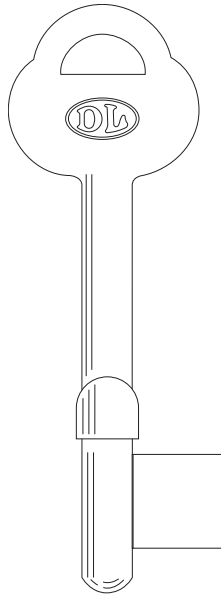

B40A

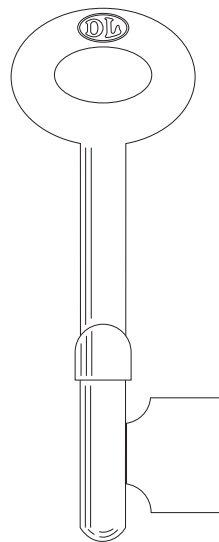

B41A

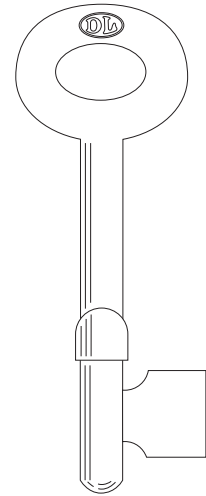

B41B

MI	MI	BI-METALLIC	BI-METALLIC	BI-METALLIC	ILCO
.20 (5.1mm)	.20" (5.1mm)	.22 (5mm)	.20 (5.1mm)	.19 (4.8mm)	Material
.12 (3 mm)	.13" (3.3mm)	.11 (2.8mm)	.08 (2mm)	.08 (2mm)	Post
.40 (10.2mm)	.34" (11.2mm)	.45 (11.4mm)	.50 (12.7mm)	.45 (11.4mm)	Neck
.41 (10.4mm)	.37" (11.9mm)	.43 (10.9mm)	.59 (15mm)	.45 (11.4mm)	Bit Height
.10 (2.5mm)	.09" (2.3mm)	.10 (2.5mm)	.09 (2.3mm)	.09 (2.3mm)	Bit Width
					Bit Thick

BIT KEYS

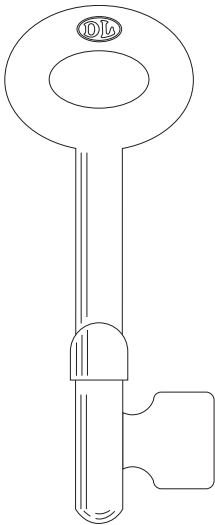

B41C

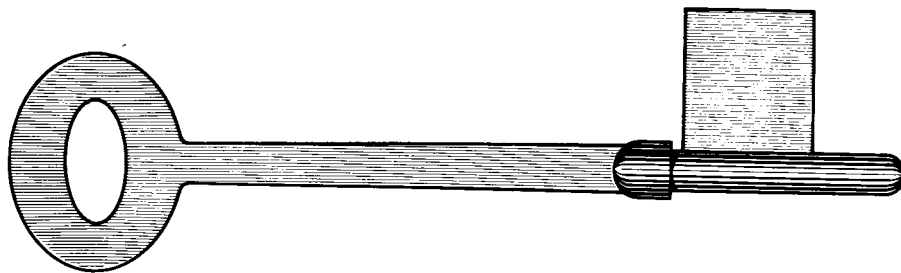

B44M

BI-METALLIC	STEEL/ZINC	ILCO
.22	.19" (4.8mm)	Material
.06	.05" (1.3mm)	Post
.45	.71" (18.0mm)	Neck
.45	.63" (16.0mm)	Bit Height
.11	.09" (2.3mm)	Bit Width
		Bit Thick

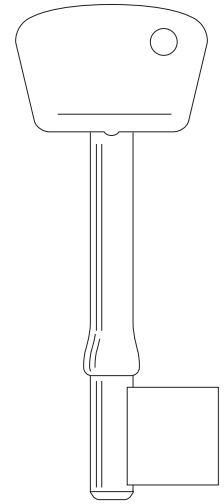
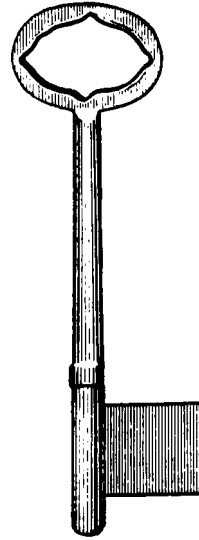
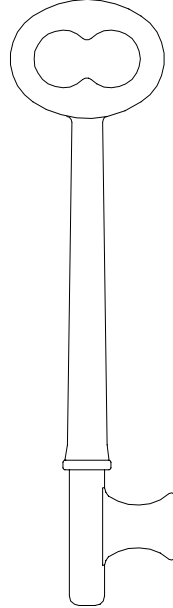
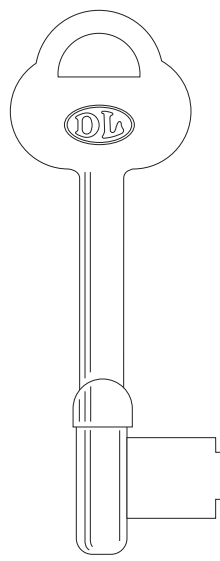
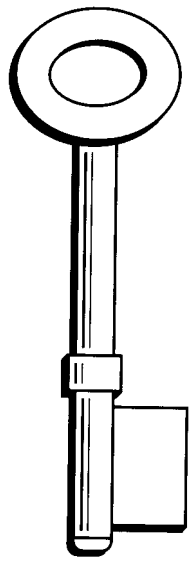
BIT KEYS

ILCO
45B
B45M
49B
51B
52B

 Material
 Post
 Neck
 Bit Height
 Bit Width
 Bit Thick

MI

BI-METALLIC

MI

BRASS

BRASS

.18" (4.6mm)

.20 (5mm)

.18" (4.6mm)

.23 (5.8mm)

.20 (5mm)

.09" (2.3mm)

.11 (2.8mm)

.12" (3.0mm)

—

.08 (2mm)

.43" (10.9mm)

.51 (13mm)

.37" (9.4mm)

.56 (14.2mm)

.34 (8.6mm)

.62" (15.7mm)

.39 (9.9mm)

.35" (8.9mm)

.87 (22.1mm)

.60 (15.2mm)

.06" (1.5mm)

.09 (2.3mm)

.06" (1.5mm)

.14 (3.6mm)

.11 (2.8mm)

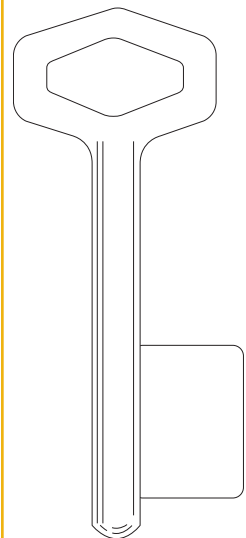
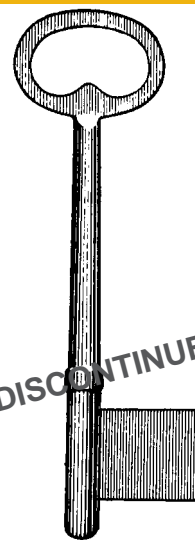
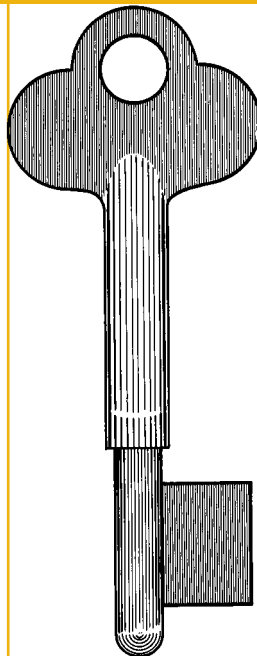
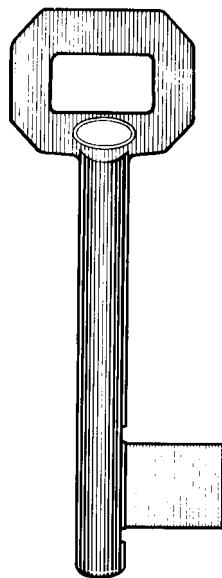
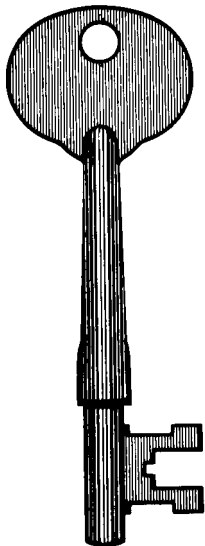
BIT KEYS

ILCO
53 MASTER
C53
54M
56B
62B

 Material
 Post
 Neck
 Bit Height
 Bit Width
 Bit Thick

MI

PRECISION CAST

MI

MI

BRASS

.19" (4.8mm)

.24" (6.1mm)

.24" (6.1mm)

.19" (4.8mm)

.24 (6.1mm)

.13" (3.3mm)

—

.16" (4.1mm)

.07" (1.8mm)

—

.43" (10.9mm)

.48" (12.2mm)

.44" (11.2mm)

.50" (12.7mm)

.63 (16.0mm)

.46" (11.7mm)

.38" (9.7mm)

.63" (16.0mm)

.47" (11.9mm)

.79 (20.0mm)

.09" (2.3mm)

.17" (4.3mm)

.14" (3.6mm)

.08" (2.0mm)

.16 (4.1mm)

BIT KEYS

66B	68M	69B	B70	ILCO
MI	MI	BRASS	MI	Material
.20" (5.1mm)	.19" (4.8mm)	.26 (6.6mm)	.19 (4.8mm)	Post
.06" (2.5mm)	.10" (3.3mm)	—	.12 (3.0mm)	Neck
.53" (14.0mm)	.47" (11.9mm)	.52 (13.2mm)	.50 (12.7mm)	Bit Height
.50" (12.7mm)	.53" (13.5mm)	.82 (20.8mm)	.52 (13.2mm)	Bit Width
.09" (2.0mm)	.08" (2.0mm)	.14 (3.6mm)	.09 (2.0mm)	Bit Thick

BIT KEYS

C70	71B	73M	78B	ILCO
PRECISION CAST	MI	MI	MI	Material
.24 (6.1mm)	.20" (5.1mm)	.19" (5.1mm)	.18" (4.8mm)	Post
.98 (24.9mm)	.10" (2.5mm)	.08" (2.3mm)	.15 (3.6mm)	Neck
.55 (14.0mm)	.44" (11.2mm)	.41" (10.2mm)	.46" (11.2mm)	Bit Height
.18 (4.8mm)	.46" (11.7mm)	.44" (11.2mm)	.68" (17.3mm)	Bit Width
.17 (4.3mm)	.06" (1.5mm)	.08" (2.0mm)	.17" (4.3mm)	Bit Thick

BIT AND BARREL

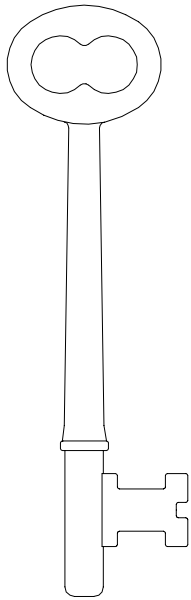
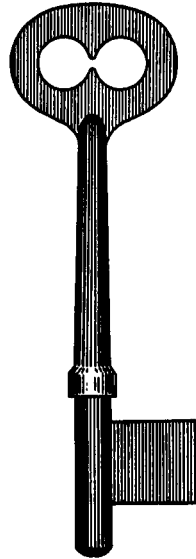
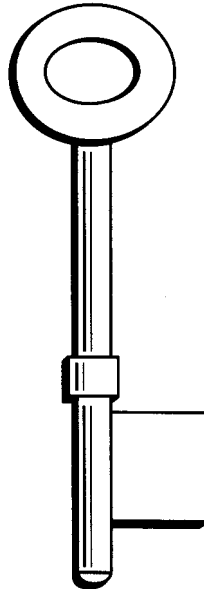
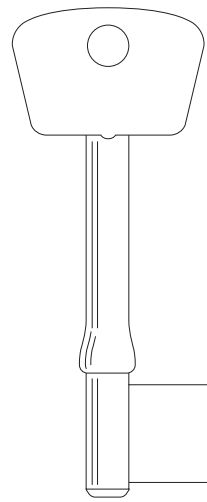
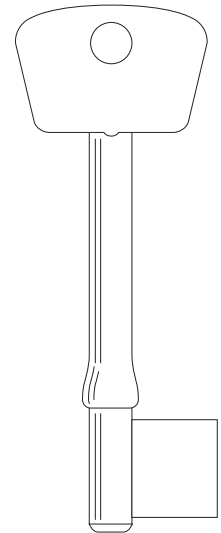
BIT KEYS

79B

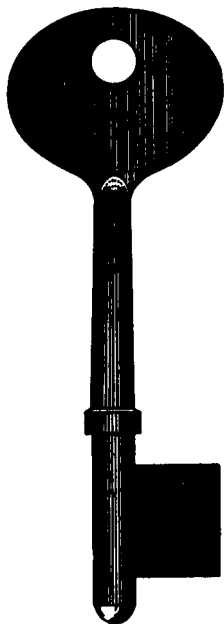
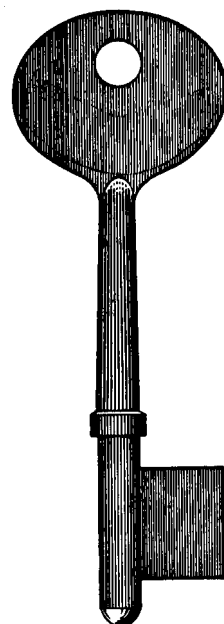
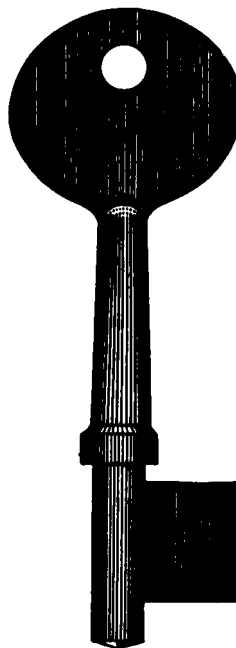
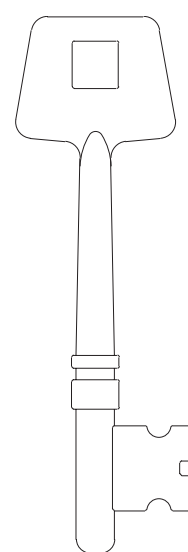
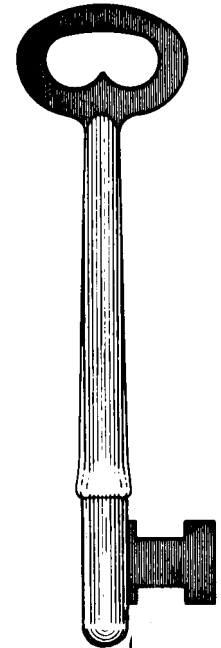
90B

91B

C110

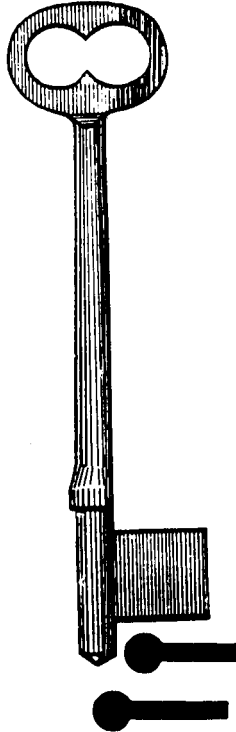
C112

ILCO					
Material	MI	MI	MI	PRECISION CAST	PRECISION CASE
Post	.21" (5.3mm)	.18" (4.6mm)	.20" (5.1mm)	.22 (5.6mm)	.21 (5.3mm)
Neck	.12" (3.0mm)	.08" (2.3mm)	.09" (2.3mm)	.52 (13.2mm)	.08 (2.3mm)
Bit Height	.44" (11.2mm)	.53" (11.4mm)	.53" (13.5mm)	.45 (11.4mm)	.36 (9.1mm)
Bit Width	.37" (9.4mm)	.50" (12.7mm)	.57" (14.5mm)	.09 (2.3mm)	.59 (15.0mm)
Bit Thick	.07" (1.8mm)	.09" (2.3mm)	.09" (2.3mm)	.10 (2.5mm)	.13 (3.3mm)

BIT KEYS

136SB

163SB

178SB

401N-2

504

ILCO					
Material	MI	MI	MI	MI	MI
Post	.24" (6.4mm)	.18" (4.8mm)	.26" (6.6mm)	.20 (5.0mm)	.22" (5.6mm)
Neck	.12" (3.0mm)	.13" (3.0mm)	.09" (2.3mm)	.09 (2.3mm)	.12" (3.0mm)
Bit Height	.44" (11.2mm)	.49" (12.2mm)	.54" (13.7mm)	.41 (10.4mm)	.48" (12.2mm)
Bit Width	.61" (15.5mm)	.52" (12.9mm)	.69" (17.5mm)	.45 (11.4mm)	.45" (11.4mm)
Bit Thick	.16" (4.1mm)	.16" (3.8mm)	.20" (5.0mm)	.12 (3.0mm)	.11" (2.8mm)

BIT KEYS



506

MI

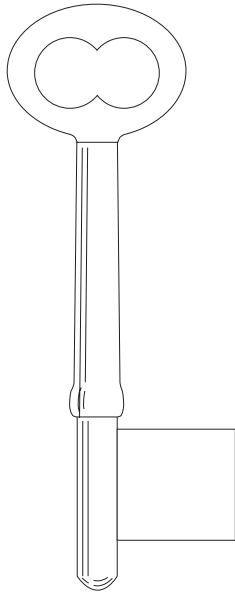

524

MI

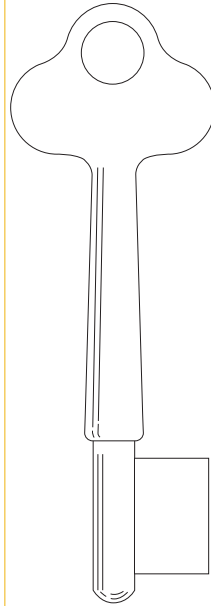

569

MI

ILCO

Material
Post
Neck
Bit Height
Bit Width
Bit Thick

.16" (4.1mm)	.22 (5.6mm)	.19 (4.8mm)
.12" (3.0mm)	.09 (2.3mm)	.10 (2.5mm)
.45" (11.4mm)	.63 (16.0mm)	.41 10.4mm()
.62" (15.7mm)	.56 (14.2mm)	.60 (15.2mm)
.06" (1.5mm)	.09 (2.3mm)	.90 (22.9mm)

BIT KEYS

BIT AND BARREL

ILCO

Material
Post
Neck
Bit Height
Bit Width
Bit Thick

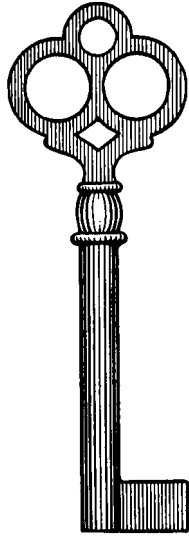
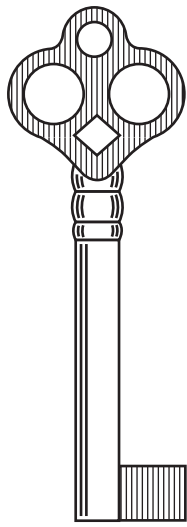
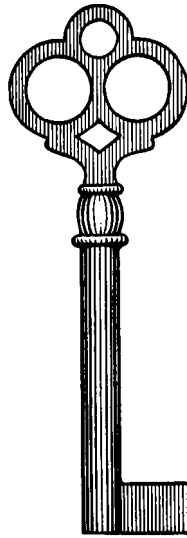
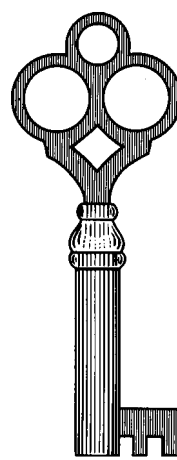
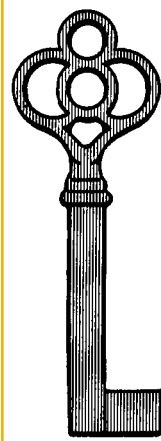
BARREL KEYS

21B

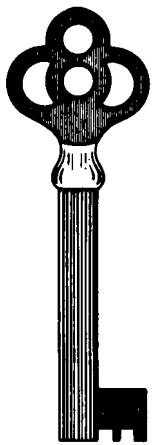
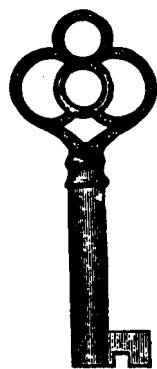
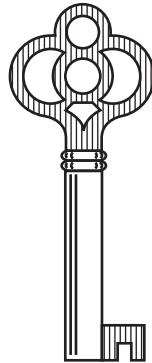
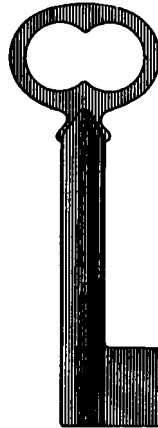
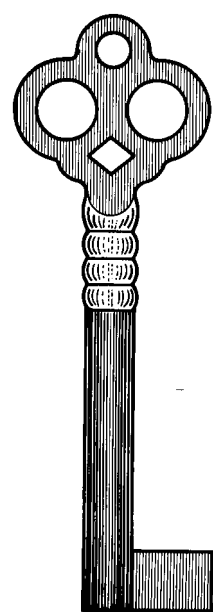
C21M

22BB

22M

23B

ILCO	21B	C21M	22BB	22M	23B
Material	MI	PRECISION CAST	MI	MI	MI
Barrel Dia.	.21" (5.3mm)	.22" (5.6mm)	.24" (6.1mm)	.21" (5.3mm)	.21" (5.3mm)
Hole Dia.	.14" (3.6mm)	.34" (8.6mm)	.15" (3.8mm)	.14" (3.6mm)	.14" (3.6mm)
Hole Depth	.68" (17.3mm)	.27" (6.9mm)	.80" (20.3mm)	.50" (12.7mm)	.50" (12.7mm)
Bit Height	.38" (9.7mm)	.11" (2.8mm)	.34" (8.6mm)	.28" (7.1mm)	.28" (7.1mm)
Bit Width	.29" (7.4mm)	.13" (3.3mm)	.27" (6.9mm)	.24" (6.1mm)	.24" (6.1mm)
Bit Thick	.11" (2.8mm)	.65" (16.5mm)	.11" (2.8mm)	.09" (2.3mm)	.09" (2.3mm)

BARREL KEYS

23M

24B

C24M

27B

C30M

ILCO	23M	24B	C24M	27B	C30M
Material	MI	MI	PRECISION CAST	MI	PREC. CAST
Barrel Dia.	.21" (5.3mm)	.19" (4.8mm)	.20 (5.0mm)	.22" (5.6mm)	.24" (6.1mm)
Hole Dia.	.14" (3.6mm)	.13" (3.3mm)	.14 (3.6mm)	.15" (3.8mm)	.16" (4.1mm)
Hole Depth	.47" (11.9mm)	.43" (10.9mm)	.22 (5.6mm)	.60" (15.2mm)	.61" (15.5mm)
Bit Height	.26" (6.6mm)	.22" (5.6mm)	.20 (5.0mm)	.37" (9.4mm)	.37" (9.4mm)
Bit Width	.29" (7.4mm)	.19" (4.8mm)	.09 (2.3mm)	.43" (10.9mm)	.28" (7.1mm)
Bit Thick	.11" (2.8mm)	.09" (2.3mm)	.65 (16.2mm)	.10" (2.5mm)	.10" (2.5mm)

BARREL KEYS

34B	C68	C82M	84B	528	ILCO
MI	PRECISION CAST	PRECISION CAST	MI	PRECISION CAST	Material
.19" (4.8mm)	.25 (6.3mm)	.23 (5.8mm)	.19" (4.8mm)	.21 (5.3mm)	Barrel Dia.
.13" (3.3mm)	.36 (9.1mm)	.31 (7.9mm)	.13" (3.3mm)	.15 (3.8mm)	Hole Dia.
.56" (14.7mm)	.56 (14.7mm)	.28 (7.1mm)	.43" (10.9mm)	.18 (4.8mm)	Hole Depth
.38" (9.7mm)	.13 (3.3mm)	.11 (2.8mm)	.22" (5.6mm)	.09 (2.3mm)	Bit Height
.34" (8.7mm)	.17 (4.3mm)	.14 (3.6mm)	.19" (4.8mm)	.15 (3.8mm)	Bit Width
.08" (2.0mm)	.80 (20.3mm)	.60 (15.2mm)	.09" (2.3mm)	.48 (12.2mm)	Bit Thick

BARREL KEYS

628	669	1500A	6750	ILCO
MI	PREC. CAST CLOCK KEY	MI	STEEL HANDCUFF KEY	Material
.22" (5.6mm)		.22 (5.6mm)		Barrel Dia.
.13" (3.3mm)		.14 (3.6mm)		Hole Dia.
.45" (11.4mm)		.19 (4.8mm)		Hole Depth
.21" (5.3mm)		.56 (14.2mm)		Bit Height
.23" (5.8mm)		.09 (2.3mm)		Bit Width
.11" (2.8mm)				Bit Thick

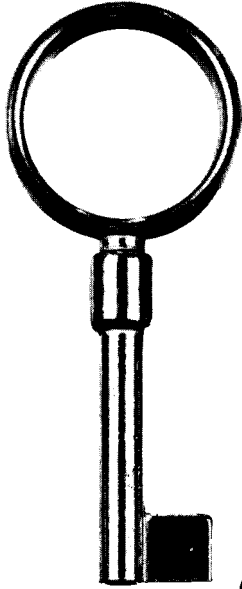
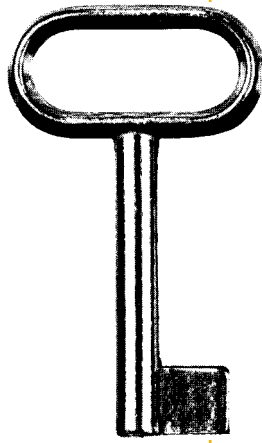
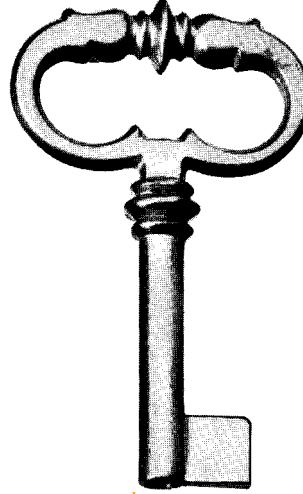
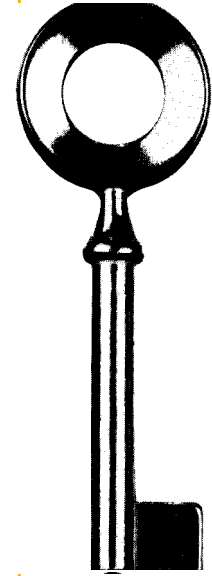
BARREL KEYS

3F-1033

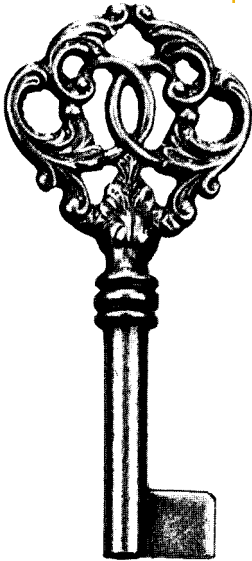
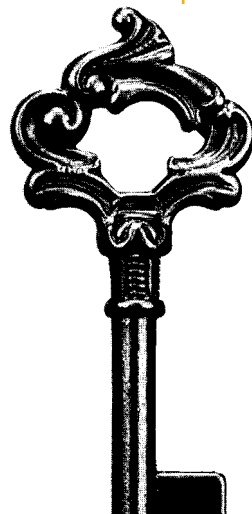
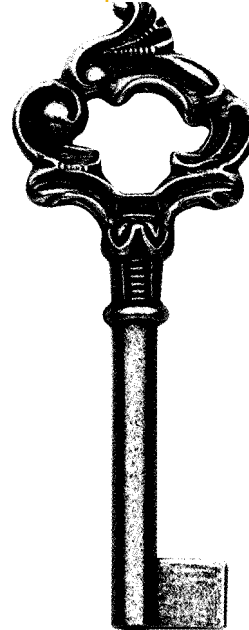
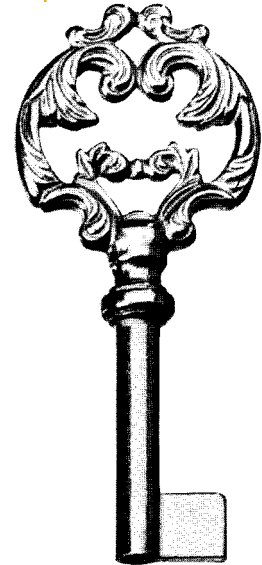
3F-1140

3F-1232

3F-1540

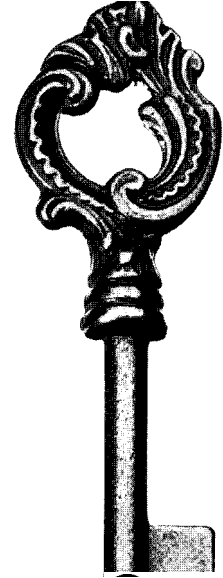
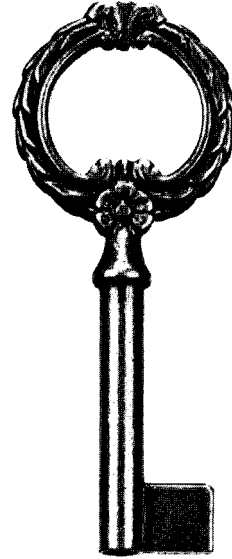
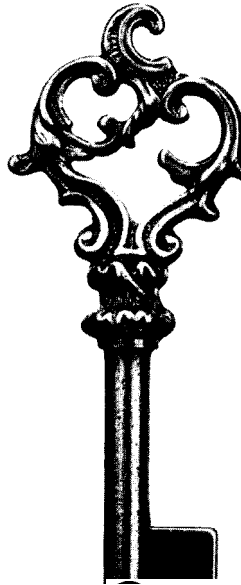
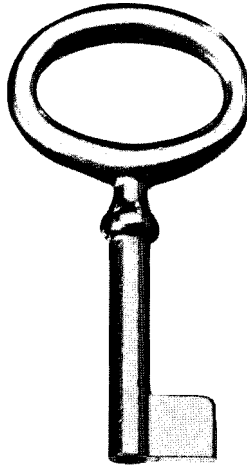
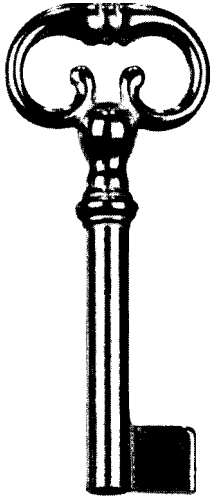
ILCO	3F-1033	3F-1140	3F-1232	3F-1540
Material	BRASS	BRASS	BRASS	BRASS
Barrel Dia.	.24" (6.0mm)	.24" (6.0mm)	.24" (6.0mm)	.24" (6.0mm)
Hole Dia.	.16" (4.0mm)	.16" (4.0mm)	.16" (4.0mm)	.16" (4.0mm)
Hole Depth	.87" (22.0mm)	.87" (22.0mm)	.87" (22.0mm)	.87" (22.0mm)
Bit Height	.36" (9.1mm)	.36" (9.1mm)	.36" (9.1mm)	.36" (9.1mm)
Bit Width	.35" (9.0mm)	.36" (9.1mm)	.34" (8.6mm)	.34" (8.7mm)
Bit Thick	.11" (2.8mm)	.12" (3.0mm)	.13" (3.2mm)	.12" (3.0mm)

BARREL KEYS

3F-1630

3F-1730

3F-1738

3F-2532

ILCO	3F-1630	3F-1730	3F-1738	3F-2532
Material	BRASS	BRASS	BRASS	BRASS
Barrel Dia.	.23" (6.0mm)	.23" (6.0mm)	.23" (6.0mm)	.23" (6.0mm)
Hole Dia.	.16" (4.0mm)	.16" (4.0mm)	.16" (4.0mm)	.16" (4.0mm)
Hole Depth	.86" (22.0mm)	.86" (22.0mm)	.86" (22.0mm)	.86" (22.0mm)
Bit Height	.36" (9.1mm)	.36" (9.1mm)	.36" (9.1mm)	.35" (8.9mm)
Bit Width	.36" (9.1mm)	.35" (9.0mm)	.34" (8.8mm)	.35" (9.0mm)
Bit Thick	.12" (3.0mm)	.12" (3.0mm)	.12" (3.0mm)	.12" (3.1mm)

BARREL KEYS



3F-2635

BRASS

.23"	(6.0mm)
.16"	(4.0mm)
.86"	(22.0mm)
.36"	(9.1mm)
.35"	(9.0mm)
.13"	(3.2mm)



3F-2830

BRASS

.23"	(6.0mm)
.16"	(4.0mm)
.86"	(22.0mm)
.36"	(9.1mm)
.36"	(9.1mm)
.13"	(3.2mm)



3F-2933

BRASS

.23"	(6.0mm)
.16"	(4.0mm)
.86"	(22.0mm)
.36"	(9.1mm)
.35"	(9.0mm)
.11"	(2.9mm)



3F-4135

BRASS

.23"	(6.0mm)
.16"	(4.0mm)
.86"	(22.0mm)
.36"	(9.1mm)
.35"	(9.0mm)
.11"	(2.9mm)



3F-4333

BRASS

.23"	(6.0mm)
.16"	(4.0mm)
.86"	(22.0mm)
.36"	(9.1mm)
.34"	(8.8mm)
.12"	(3.0mm)

ILCO

Material
Barrel Dia.
Hole Dia.
Hole Depth
Bit Height
Bit Width
Bit Thick

BARREL KEYS

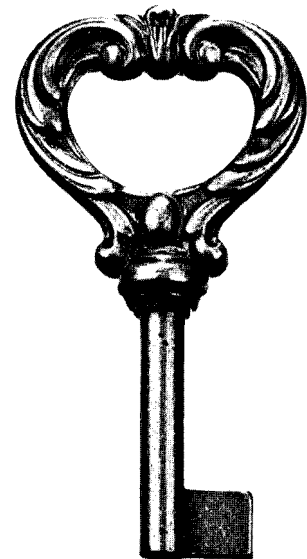
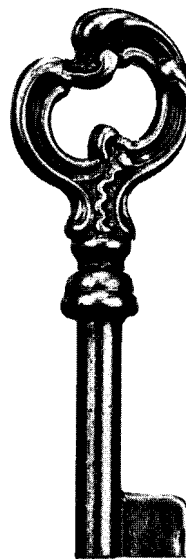
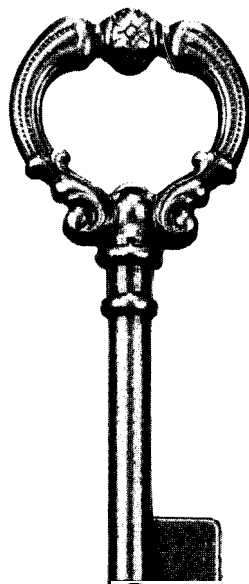
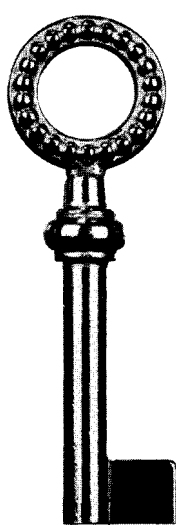
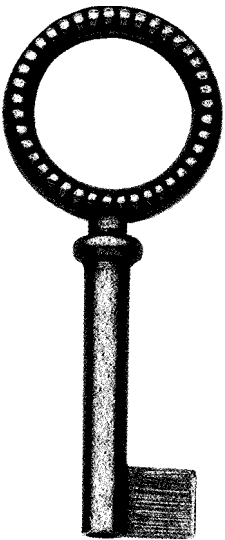

3F-4535

BRASS

.23"	(6.0mm)
.16"	(4.0mm)
.86"	(22.0mm)
.36"	(9.1mm)
.35"	(9.0mm)
.10"	(2.5mm)



3F-4735

BRASS

.23"	(6.0mm)
.16"	(4.0mm)
.86"	(22.0mm)
.36"	(9.1mm)
.34"	(8.7mm)
.12"	(3.0mm)



3F-4935

BRASS

.23"	(6.0mm)
.16"	(4.0mm)
.86"	(22.0mm)
.36"	(9.1mm)
.35"	(9.0mm)
.12"	(3.1mm)



3F-5233

BRASS

.23"	(6.0mm)
.16"	(4.0mm)
.86"	(22.0mm)
.36"	(9.1mm)
.34"	(8.6mm)
.14"	(3.5mm)



3F-6932

BRASS

.23"	(6.0mm)
.16"	(4.0mm)
.86"	(22.0mm)
.36"	(9.1mm)
.34"	(8.6mm)
.14"	(3.5mm)

ILCO

Material
Barrel Dia.
Hole Dia.
Hole Depth
Bit Height
Bit Width
Bit Thick

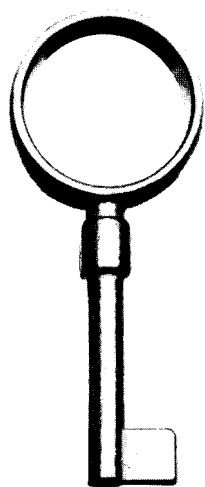
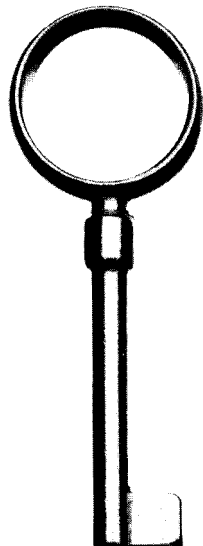
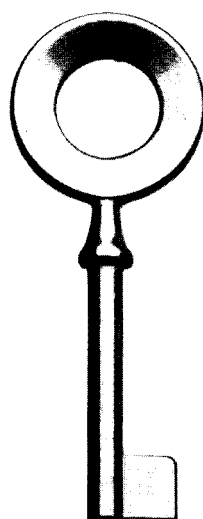
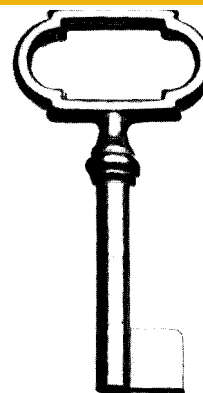
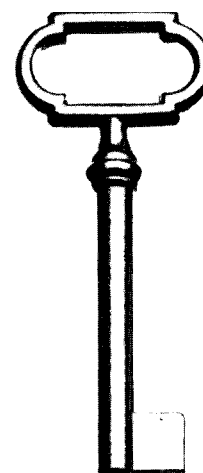
BARREL KEYS

3M-2127

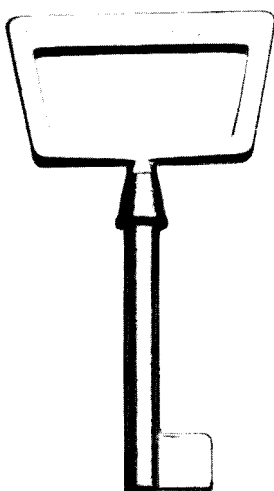
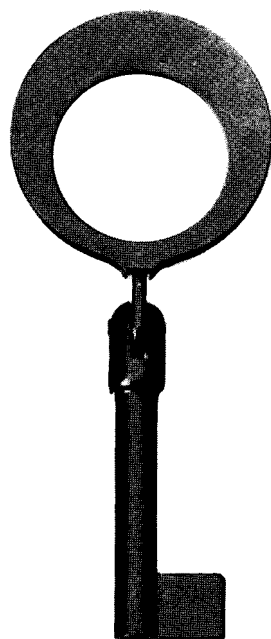
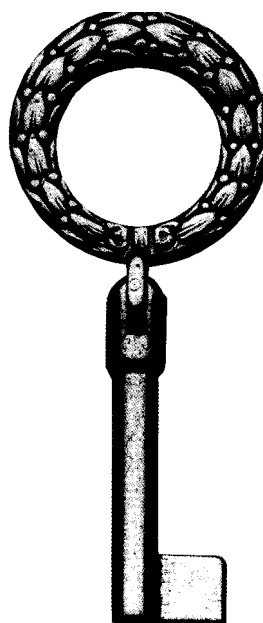
3M-2136

3M-2734

3M-3427

3M-3437

ILCO	3M-2127	3M-2136	3M-2734	3M-3427	3M-3437
Material	BRASS	BRASS	BRASS	BRASS	BRASS
Barrel Dia.	.22" (5.7mm)	.22" (5.7mm)	.22" (5.7mm)	.22" (5.7mm)	.22" (5.7mm)
Hole Dia.	.14" (3.5mm)	.14" (3.5mm)	.14" (3.5mm)	.14" (3.5mm)	.14" (3.5mm)
Hole Depth	.86" (22.0mm)	.86" (22.0mm)	.86" (22.0mm)	.86" (22.0mm)	.86" (22.0mm)
Bit Height	.25" (6.4mm)	.25" (6.4mm)	.25" (6.4mm)	.25" (6.4mm)	.25" (6.4mm)
Bit Width	.29" (7.5mm)	.29" (7.5mm)	.35" (9.0mm)	.31" (8.0mm)	.31" (8.0mm)
Bit Thick	.10" (2.5mm)	.10" (2.5mm)	.10" (2.5mm)	.10" (2.5mm)	.10" (2.5mm)

BARREL KEYS

3M-5935

3S-1832

3S-2332

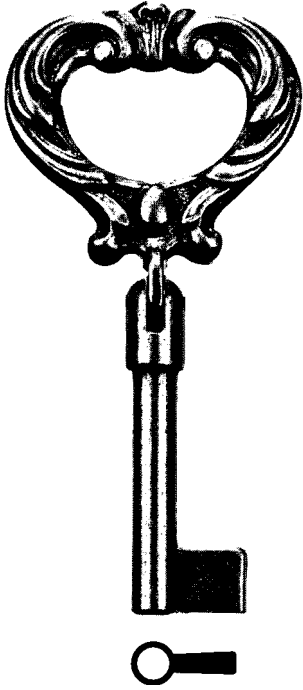
3S-5332

ILCO	3M-5935	3S-1832	3S-2332	3S-5332
Material	BRASS	BRASS	BRASS	BRASS
Barrel Dia.	.22" (5.7mm)	.23" (6.0mm)	.23" (6.0mm)	.23" (6.0mm)
Hole Dia.	.14" (3.5mm)	.16" (4.0mm)	.16" (4.0mm)	.16" (4.0mm)
Hole Depth	.86" (22.0mm)	.86" (22.0mm)	.86" (22.0mm)	.86" (22.0mm)
Bit Height	.25" (6.4mm)	.35" (9.0mm)	.36" (9.1mm)	.36" (9.1mm)
Bit Width	.30" (7.6mm)	.35" (9.0mm)	.35" (9.0mm)	.35" (9.0mm)
Bit Thick	.10" (2.5mm)	.14" (3.5mm)	.12" (3.0mm)	.12" (3.0mm)

BARREL KEYS



3S-7032

BRASS

.23"	(6.0mm)
.16"	(4.0mm)
.86"	(22.0mm)
.36"	(9.1mm)
.36"	(9.1mm)
.12"	(3.0mm)

ILCO

Material
 Barrel Dia.
 Hole Dia.
 Hole Depth
 Bit Height
 Bit Width
 Bit Thick

BIT AND BARREL

ILCO

Material
 Barrel Dia.
 Hole Dia.
 Hole Depth
 Bit Height
 Bit Width
 Bit Thick