

Section 6

This section is separated into two parts as follows:



Section 6a FLAT STEEL

Worldwide flat steel keys. Organized by lock manufacturer where possible and listed in numerical order. Only keys with keyway milling or corrugation are illustrated with a profile view.

Some keys in this section are marked “DISCONTINUED”, however they may still be available from Ilco distributors. We have left these in this directory for your reference.



Section 6b MISCELLANEOUS KEYS

A selection of special purpose keys organized by lock manufacturer where possible and listed in numerical sequence.

Some keys in this section are marked “DISCONTINUED”, however they may still be available from Ilco distributors. We have left these in this directory for your reference.

CORBIN

DUTCH LOCK

EAGLE

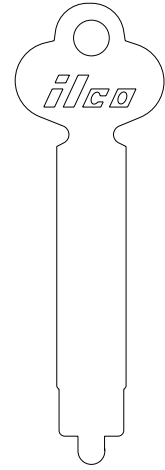
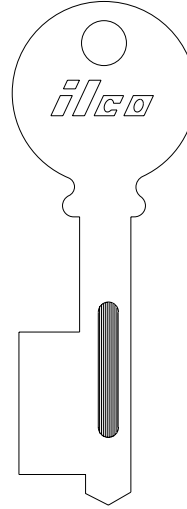
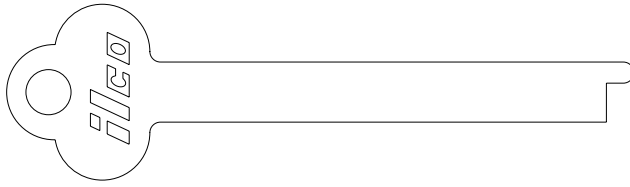

.070" - 1.8mm
.310" - 7.9mm
725

.060" - 1.5mm
.583" - 14.8mm
663

.050" - 1.3mm
.361" - 9.2mm
671

THICK
WIDTHa

EAGLE

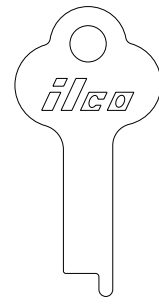
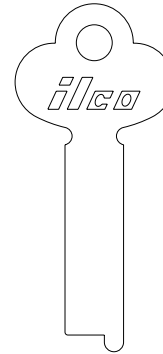
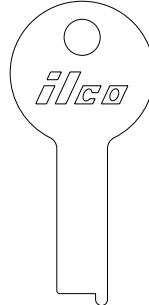
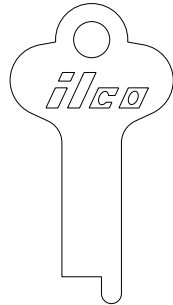
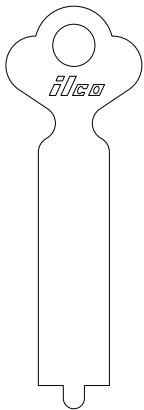

.050" - 1.3mm
.365" - 9.3mm
672

.040" - 1.0mm
.310" - 7.9mm
1214

.050" - 1.3mm
.265" - 6.7mm
1270D

.060" - 1.5mm
.300" - 7.6mm
1412

.050" - 1.3mm
.260" - 6.6mm
1417

THICK
WIDTH
ILCO

FLAT STEEL

sec page
6a 1

EAGLE

FRANKLIN

LOCKWOOD AUSTRALIA

MASTER

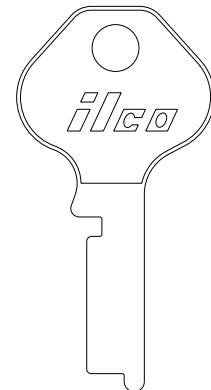
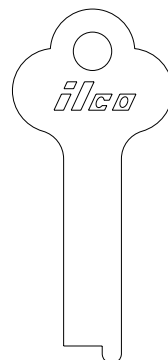
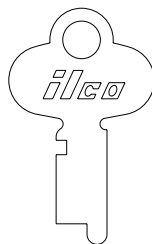
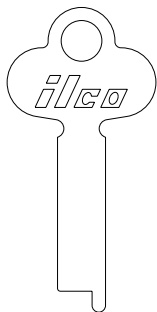

.060" - 1.5mm
.250" - 6.4mm
1417A

.050" - 1.3mm
.250" - 6.4mm
S625P

.065" - 1.7mm
.300" - 7.6mm
201

.065" - 1.7mm
.300" - 7.6mm
T153

THICK
WIDTH
ILCO

MASTER



.060" - 1.5mm
.350" - 8.9mm
687W



.050" - 1.3mm
.320" - 8.1mm
687X

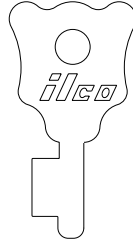

.050" - 1.3mm
.268" - 6.8mm
687Y

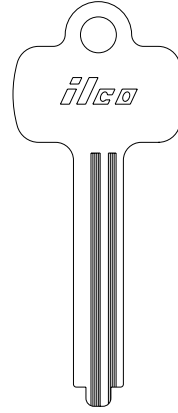

1286

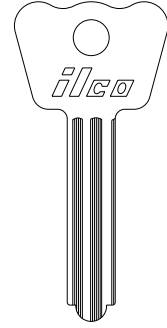

1286B 1286BR

THICK
WIDTH
ILCO

MASTER

MEDART

SLAYMAKER

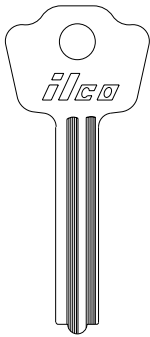

1286C

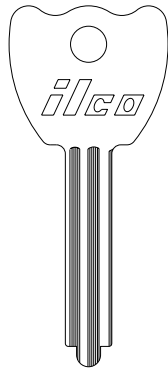

1286E R1286E

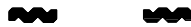
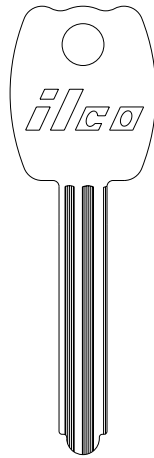

N1286 N1286R

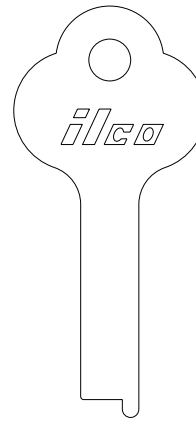

.060" - 1.5mm
.300" - 7.6mm
1332S

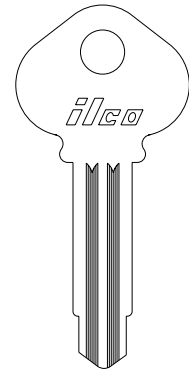

SLA10

THICK
WIDTH
ILCO

SLAYMAKER

SWITCH KEY

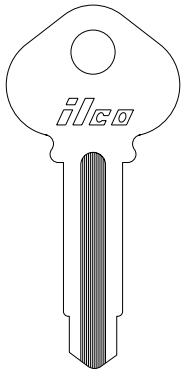

SLA11

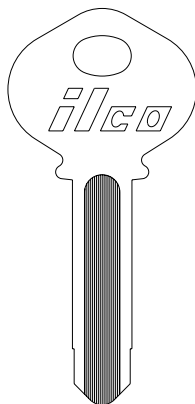

SLA12

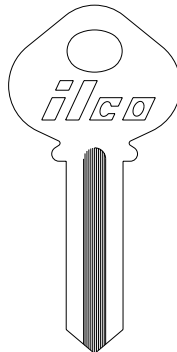

SLA13

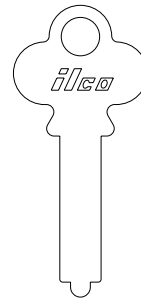

.050" - 1.3mm
.215" - 5.6mm
1418

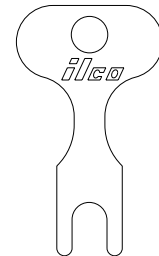

.060" - 1.5mm
.340" - 8.7mm
1425

THICK
WIDTH
ILCO

FLAT STEEL

YALE

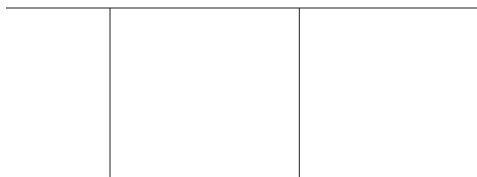
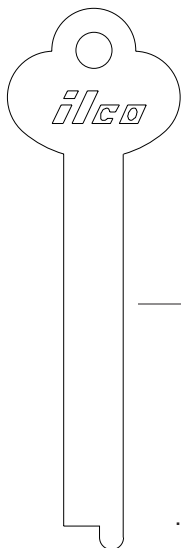
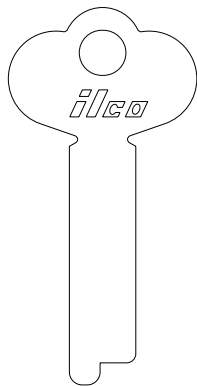

.050" - 1.3mm
.340" - 8.7mm
623S

.060" - 1.5mm
.310" - 7.9mm
621A

.040" - 1.0mm
.310" - 7.9mm
U621A

.050" - 1.2mm
.310" - 7.9mm
1221AL

THICK
WIDTH
ILCO

YALE

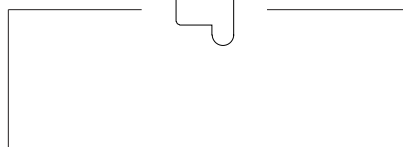
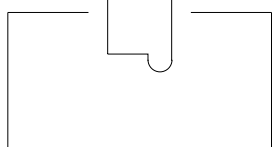
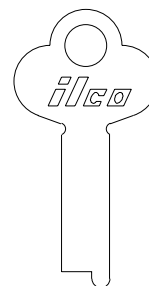
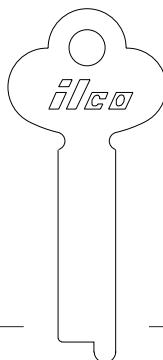
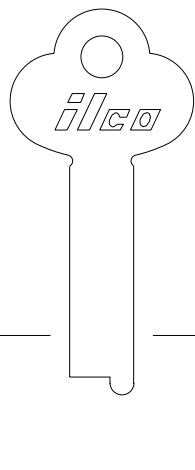

.060" - 1.5mm
.335" - 8.5mm
O1223

.050" - 1.3mm
.335" - 8.5mm
O1223L

.050" - 1.3mm
.300" - 7.6mm
1224

.060" - 1.5mm
.300" - 7.6mm
1224F

.040" - 1.0mm
.300" - 7.6mm
1224L

.040" - 1.0mm
.250" - 6.4mm
1225

THICK
WIDTH
ILCO

YALE

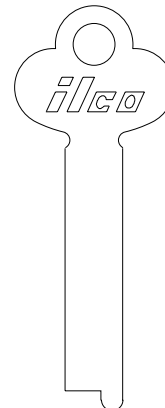
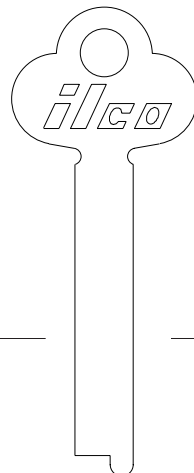
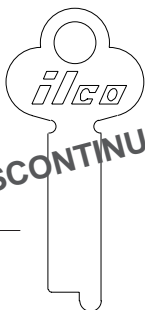
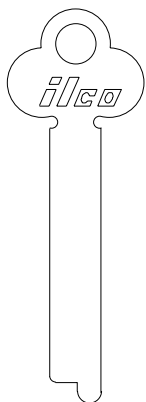

DISCONTINUED

.050" - 1.3mm
.270" - 6.8mm
1225A

.040" - 1.0mm
.275" - 7.0mm
1225D

.060" - 1.5mm
.275" - 7.0mm
625DH

.040" - 1.0mm
.305" - 7.8mm
1225E

.060" - 1.5mm
.305" - 7.8mm
625EH

.040" - 1.0mm
.300" - 7.6mm
1225G

THICK
WIDTH
ILCO

FLAT STEEL

YALE

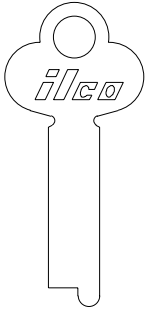

.040" - 1.0mm
.265" - 6.7mm
1225PL

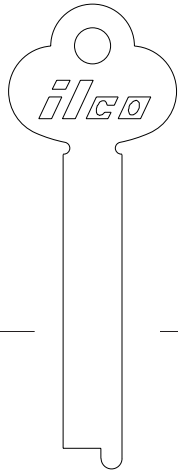

.050" - 1.3mm
.305" - 7.8mm
1370



.060" - 1.5mm
.305" - 7.8mm
770

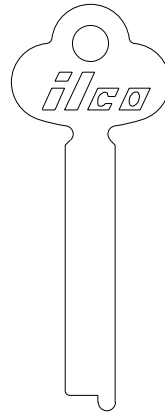

.040" - 1.0mm
.260" - 6.6mm
1422

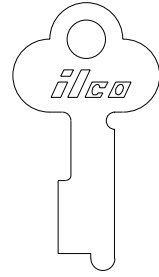

.050" - 1.3mm
.295" - 7.5mm
1427

THICK
WIDTH
ILCO

MISCELLANEOUS FLAT STEEL

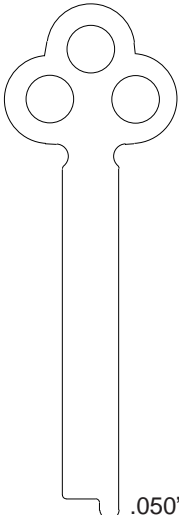

.050" - 1.3mm
.300" - 7.6mm
T45

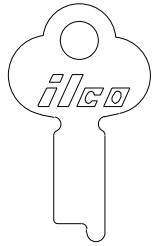

.050" - 1.3mm
.265" - 6.7mm
T50

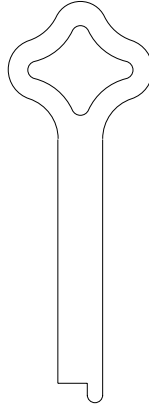

.040" - 1.0mm
.250" - 6.4mm
T64

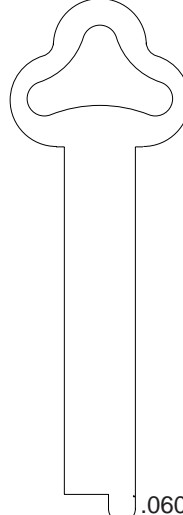

.060" - 1.5mm
.375" - 9.5mm
T70

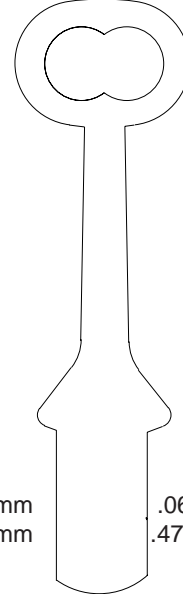

.060" - 1.5mm
.475" - 12.1mm
T77

THICK
WIDTH
ILCO

FLAT STEEL

sec page
6a 4

MISCELLANEOUS FLAT STEEL

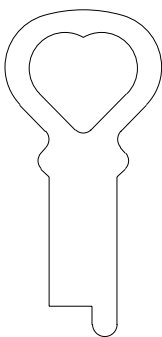

.070" - 1.8mm
.355" - 9.0mm
T80

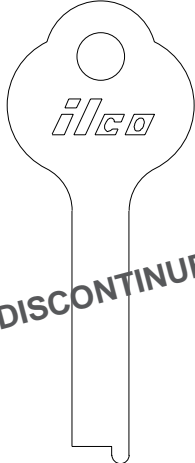

.060" - 1.5mm
.300" - 7.6mm
T92

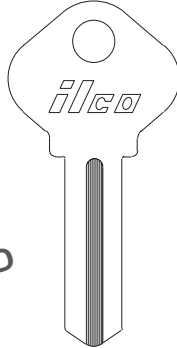

T105

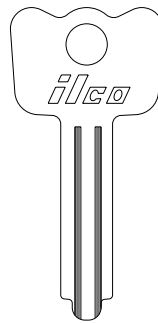

T107

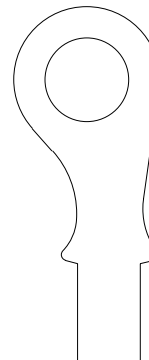

.050" - 1.3mm
.330" - 8.4mm
T131

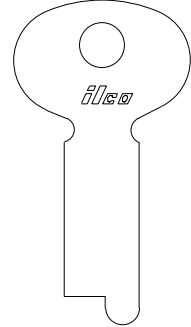

.065" - 1.7mm
.390" - 9.9mm
355ST

THICK
WIDTH
ILCO

MISCELLANEOUS FLAT STEEL

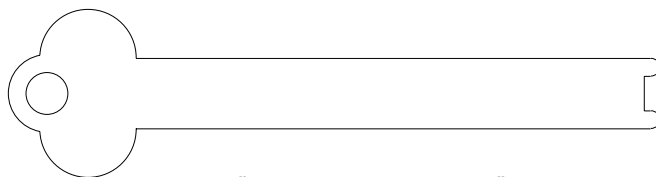
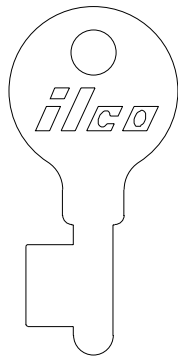
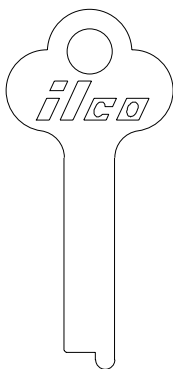

.060" - 1.5mm
.365" - 9.3mm
606AH

.050" - 1.3mm
.365" - 9.3mm
1206A

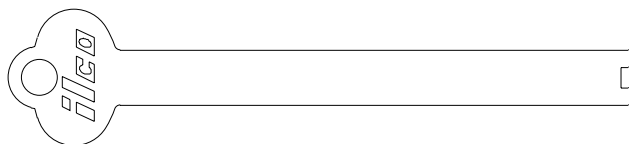

.050" - 1.3mm
.295" - 7.5mm
606L

.060" - 1.5mm
.295" - 7.5mm
606LH

THICK
WIDTH
ILCO

.050" - 1.3mm
.265" - 6.7mm
E374

.065" - 1.7mm
.460" - 11.7mm
E375

MISCELLANEOUS FLAT STEEL

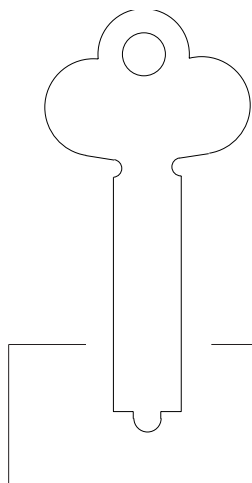

.060" - 1.5mm
.350" - 8.1mm
610B



.050" - 1.3mm
.350" - 8.1mm
610BL

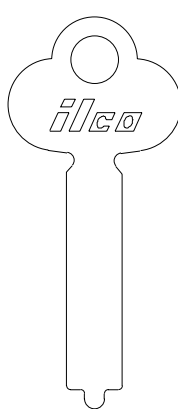

.060" - 1.5mm
.300" - 7.5mm
611

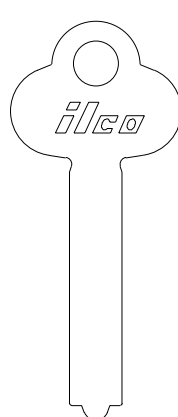

.050" - 1.3mm
.265" - 6.7mm
U611B

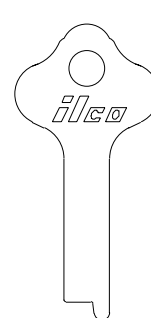

.040" - 1.0mm
.250" - 6.4mm
615



.050" - 1.3mm
.480" - 12.2mm
616

DISCONTINUED

THICK
WIDTH
ILCO

MISCELLANEOUS FLAT STEEL

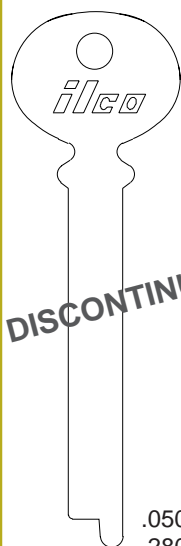

DISCONTINUED

.050" - 1.3mm
.280" - 7.1mm
617GL

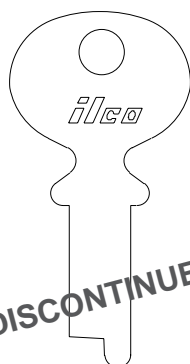

DISCONTINUED

.050" - 1.3mm
.316" - 8.0mm
617J

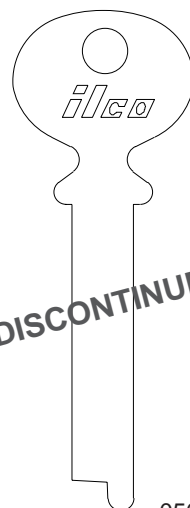

DISCONTINUED

.050" - 1.3mm
.320" - 8.1mm
617JL

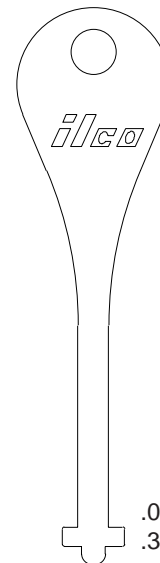

.040" - 1.0mm
.325" - 8.3mm
632M

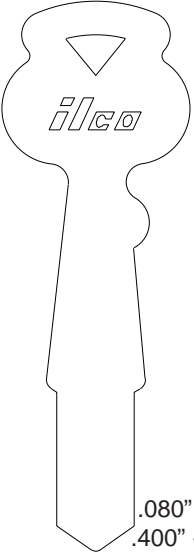
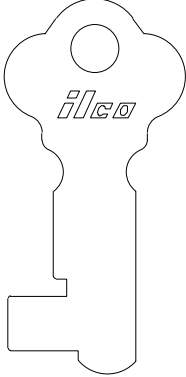
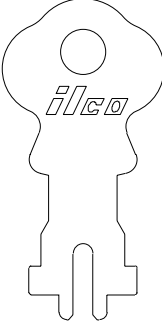
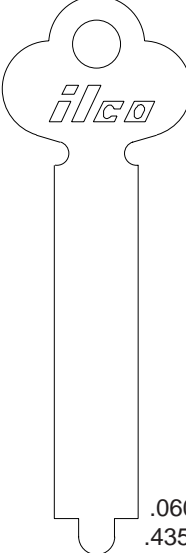

THICK
WIDTH
ILCO

MISCELLANEOUS FLAT STEEL

			
.080" - 2.0mm .400" - 10.2mm 634	.075" - 1.7mm .668" - 17.0mm 662	.060" - 1.5mm .562" - 14.3mm 667	.060" - 1.5mm .435" - 11.0mm 1209

THICK
WIDTH
ILCO

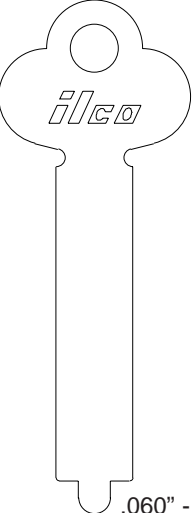
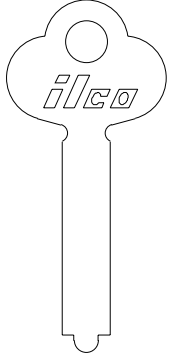
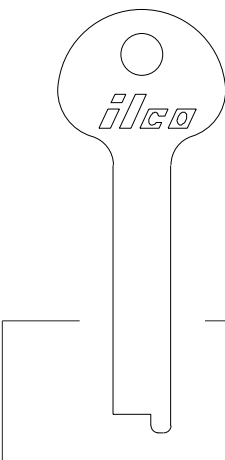
MISCELLANEOUS FLAT STEEL

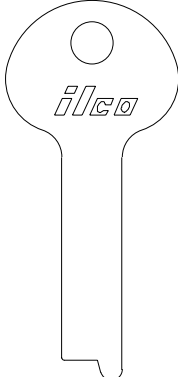
				
.060" - 1.5mm .400" - 10.2mm 1210A	.050" - 1.3mm .250" - 6.4mm 1211B	.050" - 1.3mm .300" - 7.6mm 1213A	.060" - 1.5mm .300" - 7.6mm 1213AH	.060" - 1.5mm .315" - 8.0mm 1213AS

THICK
WIDTH
ILCO

MISCELLANEOUS FLAT STEEL

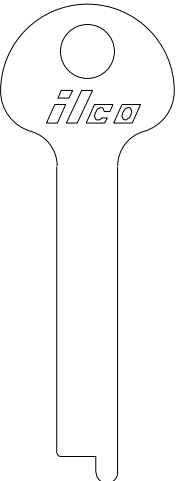
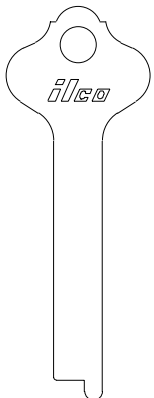
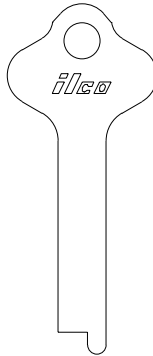
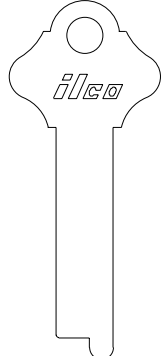
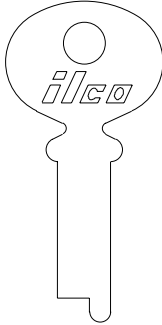
				
.050" - 1.3mm .315" - 8.0mm O1213	.040" - 1.0mm .250" - 6.4mm 1215A	.040" - 1.0mm .250" - 6.4mm 1215B	.050" - 1.3mm .290" - 7.4mm O1215	.040" - 1.0mm .275" - 7.0mm 1217

THICK
WIDTH
ILCO

FLAT STEEL

MISCELLANEOUS FLAT STEEL

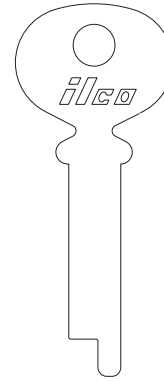
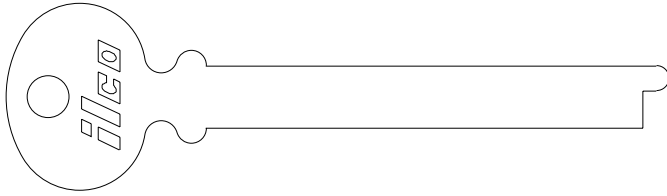

THICK
WIDTH
ILCO

.050" - 1.3mm
.325" - 8.3mm
1217A

.050" - 1.3mm
.270" - 6.9mm
1217D

MISCELLANEOUS FLAT STEEL

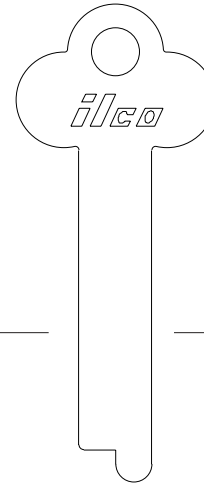
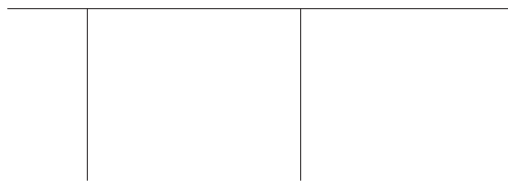
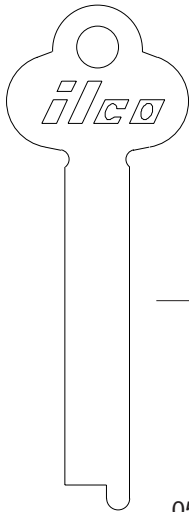

THICK
WIDTH
ILCO

.050" - 1.3mm
.335" - 8.5mm
1221L

.040" - 1.0mm
.335" - 8.5mm
O1221L

.060" - 1.5mm
.335" - 8.5mm
621

.050" - 1.3mm
.380" - 9.7mm
1222AL

.040" - 1.0mm
.380" - 9.7mm
1222E

MISCELLANEOUS FLAT STEEL

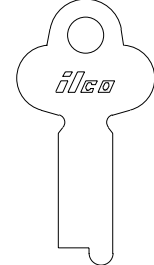
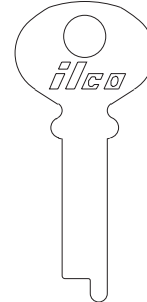
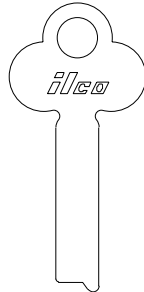
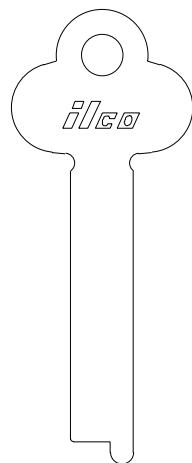
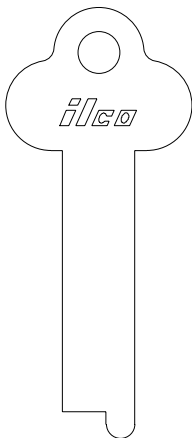

THICK
WIDTH
ILCO

.050" - 1.3mm
.375" - 9.5mm
1222B

.050" - 1.3mm
.325" - 8.3mm
1222L

.040" - 1.0mm
.225" - 5.7mm
1225BL

.040" - 1.0mm
.245" - 6.2mm
1225F

.050" - 1.3mm
.285" - 7.2mm
O1225N

MISCELLANEOUS FLAT STEEL

<p>.050" - 1.3mm .435" - 11.1mm 1226</p>	<p>.050" - 1.3mm .312" - 7.9mm 1233M</p>	<p>.070" - 1.8mm .312" - 7.9mm 633MH</p>	<p>.040" - 1.0mm .285" - 7.2mm 1239</p>	<p>THICK WIDTH ILCO</p>
---	---	---	--	--

MISCELLANEOUS FLAT STEEL

<p>.070" - 1.8mm .300" - 7.6mm 1242</p>	<p>.060" - 1.5mm .300" - 7.6mm 1242L</p>	<p>.050" - 1.3mm .375" - 9.5mm 1243D</p>	<p>.060" - 1.5mm .575" - 14.6mm 1259</p>	<p>THICK WIDTH ILCO</p>
--	---	---	---	--

MISCELLANEOUS FLAT STEEL

<p>.040" - 1.0mm .300" - 7.6mm 1270</p>	<p>.060" - 1.5mm .300" - 7.6mm 1270H</p>	<p>.040" - 1.0mm .300" - 7.6mm 1270A</p>	<p>.050" - 1.3mm .255" - 6.5mm 1270B</p>	<p>.060" - 1.5mm .310" - 7.9mm 1270C</p>	<p>THICK WIDTH ILCO</p>
--	---	---	---	---	--

FLAT STEEL

MISCELLANEOUS FLAT STEEL

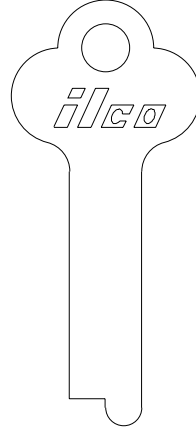
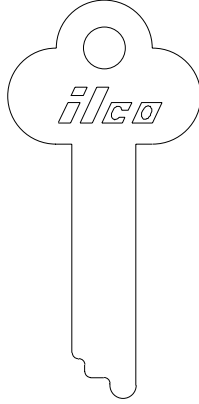
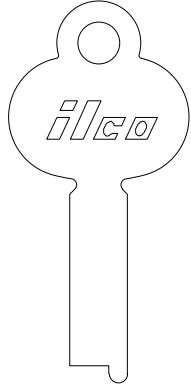
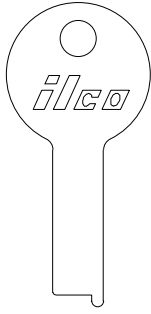

THICK
WIDTH
ILCO

.065" - 1.6mm
.265" - 6.5mm
1271H

.060" - 1.5mm
.300" - 7.6mm
1303

.060" - 1.5mm
.325" - 8.3mm
1306

.050" - 1.3mm
.375" - 9.5mm
1306A

MISCELLANEOUS FLAT STEEL

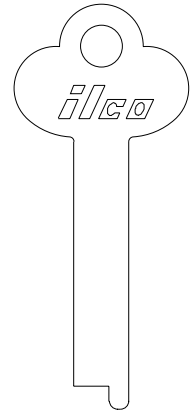
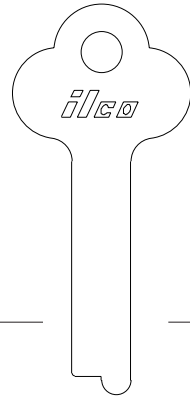
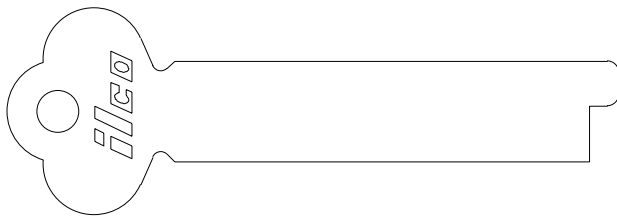

THICK
WIDTH
ILCO

.070" - 1.8mm
.525" - 13.3mm
1309

.050" - 1.3mm
.305" - 7.8mm
1321

.060" - 1.5mm
.305" - 7.8mm
1321H

.050" - 1.3mm
.285" - 7.2mm
1366

MISCELLANEOUS FLAT STEEL

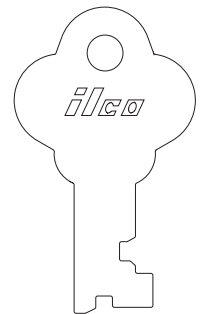
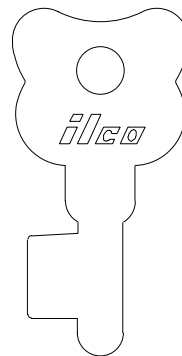
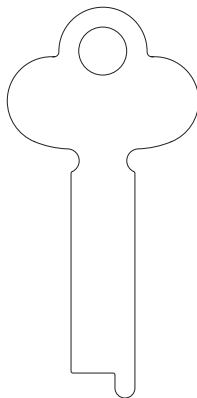
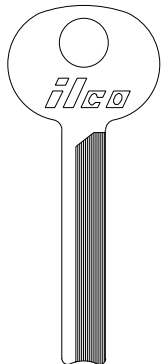
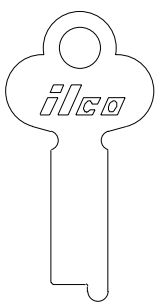

THICK
WIDTH
ILCO

.050" - 1.3mm
.300" - 7.6mm
1426

T28





.050" - 1.3mm
.335" - 8.5mm
T37L

.060" - 1.5mm
.495" - 12.6mm
T127

.055" - 1.3mm
.320" - 8.1mm
4436

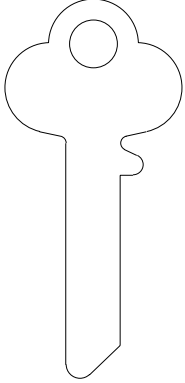

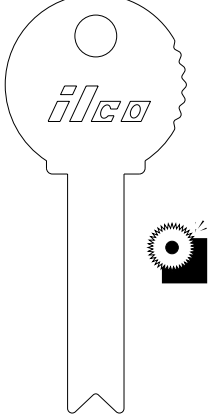



AMER. TOURISTER BELL LOCKER, CABINET LOCK & DUDLEY CHENEY

 <p>NICKEL SILVER</p> <p>.040" - 1.0mm .285" - 7.2mm</p> <p>1031</p>	 <p>BRASS</p> <p>.085" - 2.2mm .300" - 7.6mm</p> <p>1033D</p>	 <p>BRASS</p> <p>.085" - 2.2mm .295" - 7.5mm</p> <p>1033F</p>	 <p>STEEL</p>  <p>C350</p>
--	---	---	---

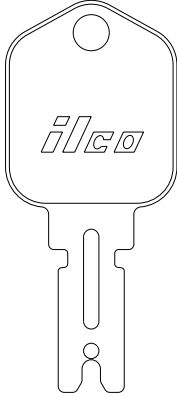
THICK
WIDTH
ILCO

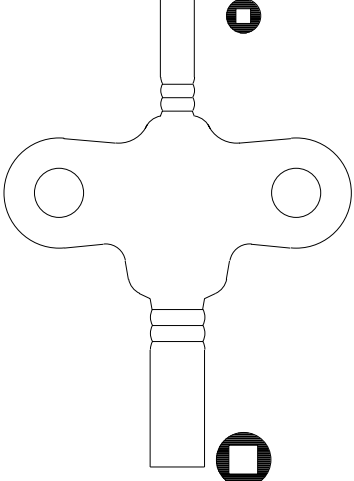
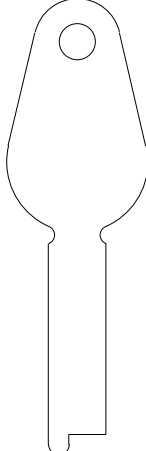
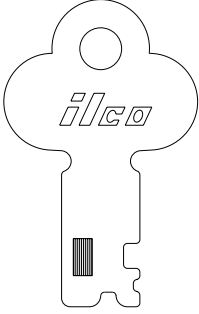
CLARK FORK LIFT CLOCK KEY DURAND LOCKER EAGLE

 <p>STEEL</p>  <p>.080" - 2.0mm .344" - 8.7mm</p> <p>1430</p>	 <p>PRECISION CAST</p> <p>669</p>	 <p>NICKEL SILVER</p> <p>.060" - 1.5mm .300" - 7.6mm</p> <p>1033A</p>	 <p>STEEL</p>  <p>T39</p>
---	--	---	---

THICK
WIDTH
ILCO

EAGLE

 <p>STEEL</p> <p>T40</p>	 <p>STEEL</p>  <p>T41</p>	 <p>STEEL</p> <p>816A</p>	 <p>NICKEL SILVER</p> <p>.050" - 1.3mm .375" - 9.5mm</p> <p>S1306A</p>	 <p>NICKEL SILVER</p> <p>.050" - 1.3mm .275" - 7.0mm</p> <p>1322S</p>
--	--	---	---	---

THICK
WIDTH
ILCO

MISCELLANEOUS

sec page
6b 1



EAGLE - JAPAN CAR ANTENNA

EAGLE

EVERLASTING

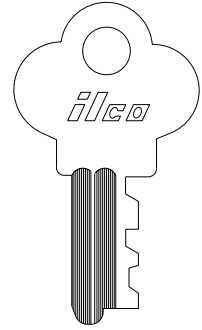
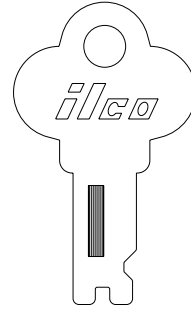
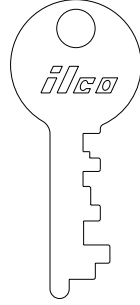
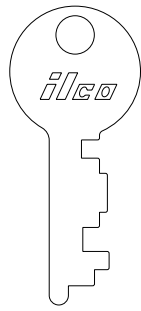
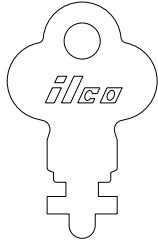

STEEL

STEEL

STEEL

STEEL

STEEL

.050" - 1.3mm
.365" - 9.3mm

1416

2712

2714

T44

T95

THICK
WIDTH
ILCO

EVERLASTING

EXCELSIOR

GAS & COMBINE

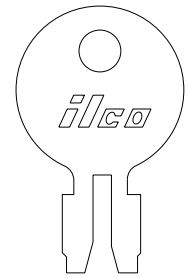
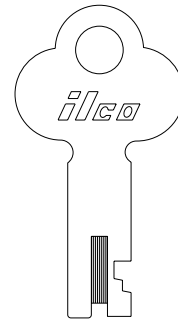
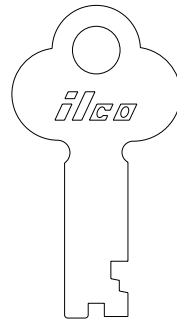
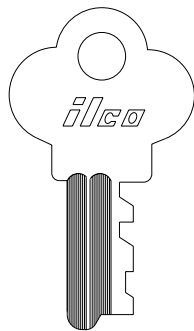
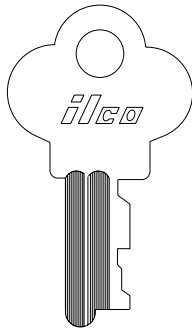

STEEL

STEEL

STEEL

STEEL

STEEL

T96

T97

T72

T139

666

THICK
WIDTH
ILCO

GERMAN BANK LOCK

GERSTNER TOOL BOX

JAPAN CAR ANTENNA

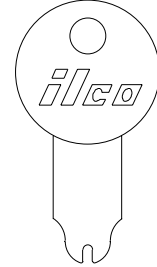
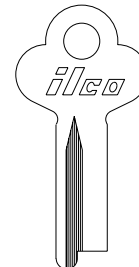
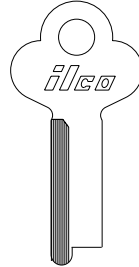
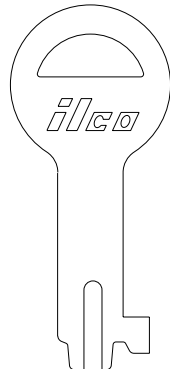
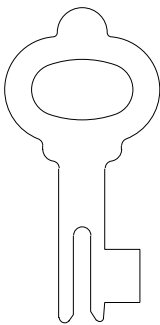

STEEL

STEEL

BRASS

BRASS

STEEL

.070" - 1.8mm
.421" - 10.7 mm

660

665

1013G

1013GR

619

THICK
WIDTH
ILCO

MISCELLANEOUS

LUCAS LYONS MEDART

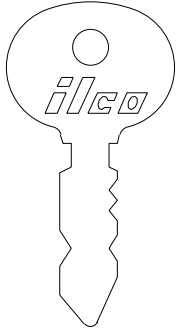

STEEL

LU1

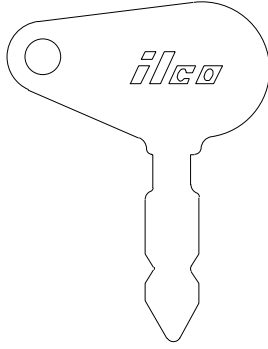

STEEL

LU2

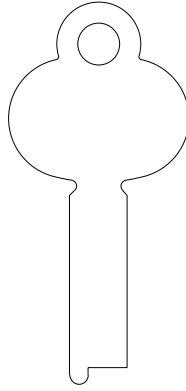

NICKEL SILVER
.060" - 1.5mm
.300" - 7.6mm
1303S

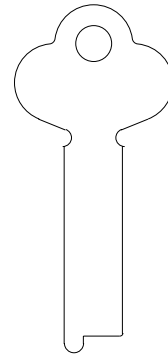

NICKEL SILVER
.060" - 1.5mm
.305" - 7.8mm
1326

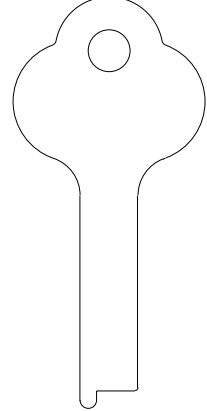

NICKEL SILVER
.060" - 1.5mm
.300" - 7.6mm
1332

THICK
WIDTH
ILCO

NEUMAN POLARIS PRESTO



DISCONTINUED

STEEL
T73

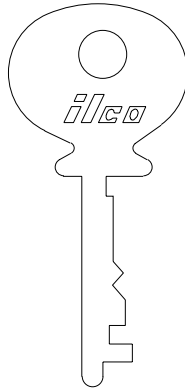

STEEL
T74

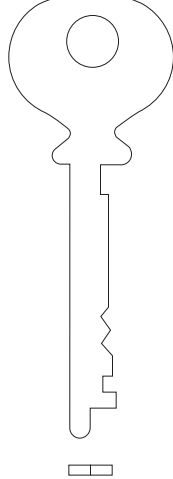

STEEL
T75

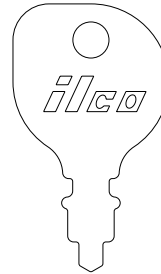

STEEL
1148

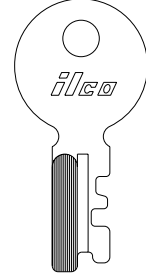

STEEL
T60

THICK
WIDTH
ILCO

PRESTO SAMSONITE



STEEL
T88

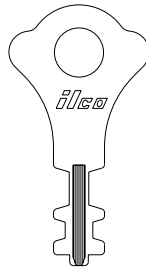

STEEL
T89

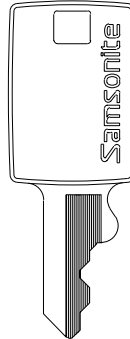

BRASS
70S

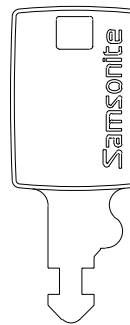

BRASS
80S

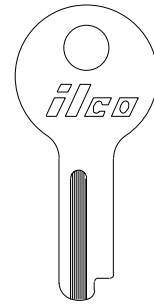

STEEL
149

THICK
WIDTH
ILCO

MISCELLANEOUS

SAMSONITE

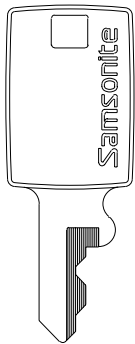

BRASS
170S

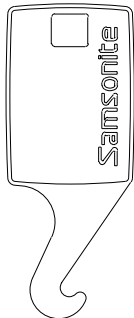

BRASS
171S

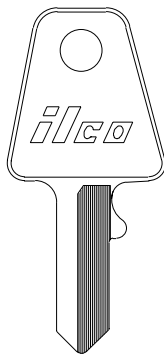

BRASS
170S1

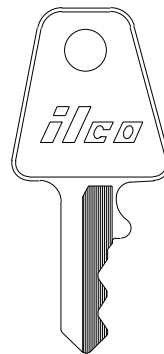

BRASS
170S6

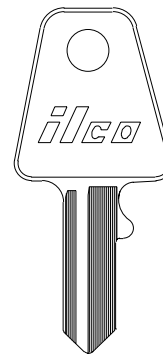

BRASS
S170S1

THICK
WIDTH
ILCO

YALE

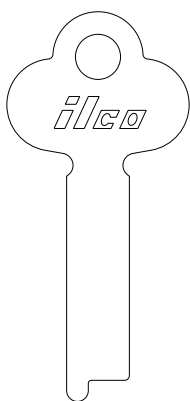

NICKEL SILVER
.060" - 1.5mm
.335" - 8.4mm
37D

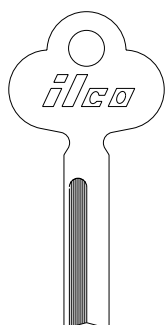

NICKEL SILVER

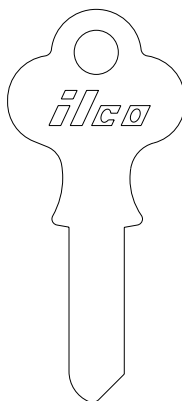
51

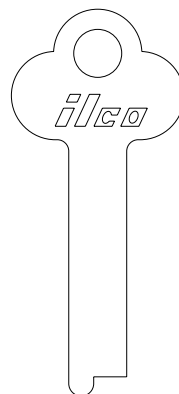

BRASS
94

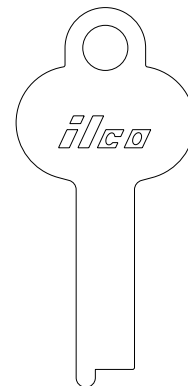

NICKEL SILVER
143C



NICKEL SILVER
703S

THICK
WIDTH
ILCO

YALE

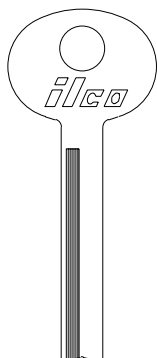

NICKEL SILVER

719S

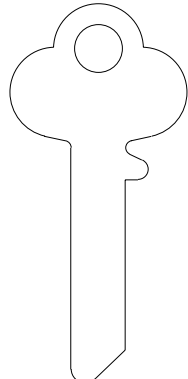

NICKEL SILVER
.040" - 1.0mm
.285" - 7.2mm
1031

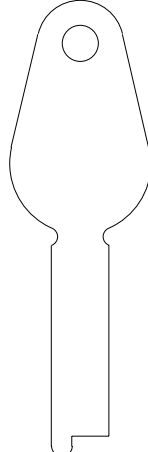

NICKEL SILVER
.060" - 1.5mm
.300" - 7.6mm
1033A

THICK
WIDTH
ILCO

MISCELLANEOUS

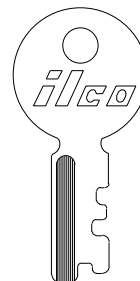

STEEL

T46

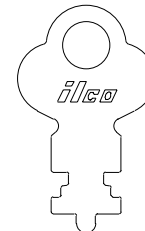

STEEL
T86



MISCELLANEOUS

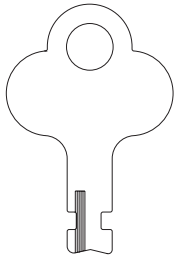

STEEL
T124



STEEL
TS149

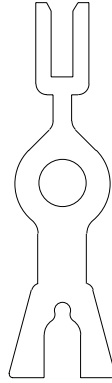

STEEL
TS150

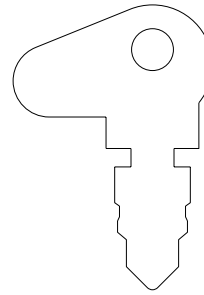

STEEL
1147

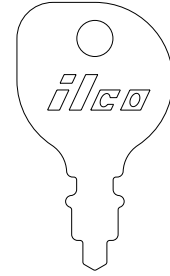

STEEL
1148

THICK
WIDTH
ILCO

MISCELLANEOUS

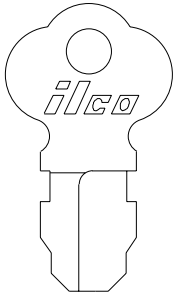

STEEL
3916-21

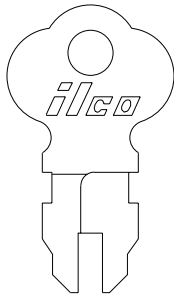

STEEL
3916-22

THICK
WIDTH
ILCO

MISCELLANEOUS

THICK
WIDTH
ILCO